

# INDOOR IP55 SERIES

---



Free standing IP55 industrial cabinets; 19" rack cabinets with full protection against dust, water and mechanical impacts. All necessary protection levels provided for protect the housed devices





### **High Strength**

IP55 series has the capacity of carrying heavy devices to be housed due to the extra strength carcass system in the welded monoblock structure and the surface panels made of galvanized 1.5mm material.

### **Water and Dust Proof**

Side, front, rear panels and top covers' sealed structure provide maximum protection against dust and water ingress.



### **Cable Entry**

1xPG29 cable gland with gasket, 2xPG21 cable gland with gasket, 1xPG21 blind plugs are available on the bottom metal plate.  
Can be designed according to demand.

### **Multiple Access**

Removable feature of all panels, allowing access from all sides.



### **Front Door**

---

Standard model is solid metal door. Optionally, glass door is available.

### **Rear Door**

---

Standard model is solid metal door. Optionally, glass door is available.

### **Assembly Structure**

---

It is shipped as assembled in one piece. Disassembled delivery can be provided upon request.

### **High Security**

---

For maximum security, front and rear doors are equipped with the 3-point handled locking system.

### **Air Conditioning**

---

If requested, industrial air conditioners can be installed on the top, side, front or rear panels.

### **Plinth**

---

The optional plinth module provides protection for cable bundles entering from below. Optionally, the plinth height can be changed.







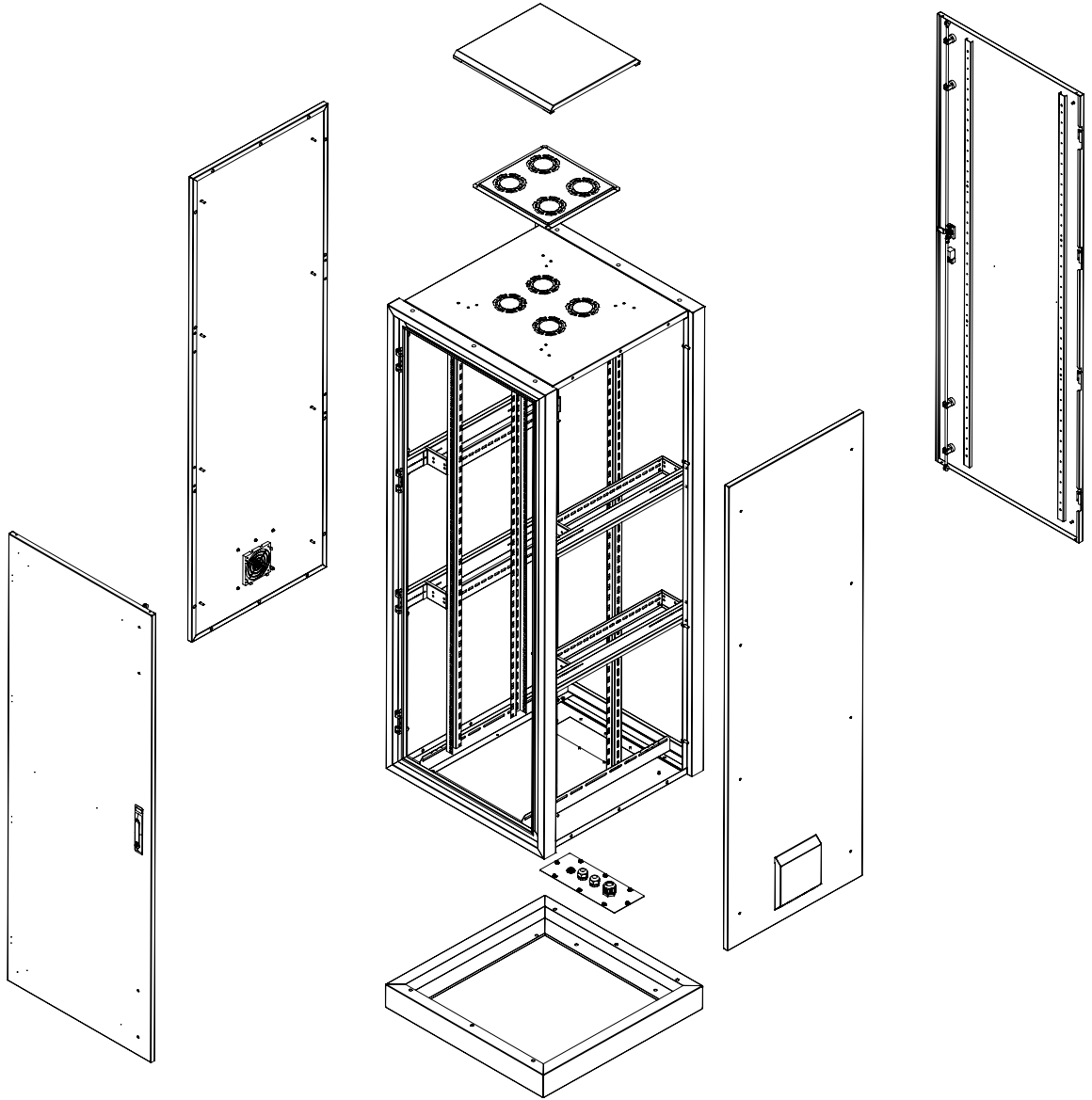

#### Material

- 1.5 mm GLV

#### IP Classification

- As a standard IP55

#### Color Options

- RAL9005 Black
- RAL7035 White

#### Loading Capacity

- Recommended up to 1500 kg Loading capacity

#### Doors

- Complete metal and complete metal framed glass door options are available.
- 3 point locking system
- Doors can be opened to 110 degree
- Doors can be opened to left or right direction

#### Mounting Rails

- 1.5mm DX51D galvanic
- 19" Mounting rails; adjustable in depth of the cabinet

#### Side Panels

- Standard side panels are internally screwed. Locking system is available, Side panels are removable.

#### Bottom

- There is a Gland mounted panel on the bottom cover. Special work can be done upon request.

#### Ground contact

- Plinth is available as an option

#### Top Sheet

- Fan module can be mounted. Top cover canopy system allows to Air passage



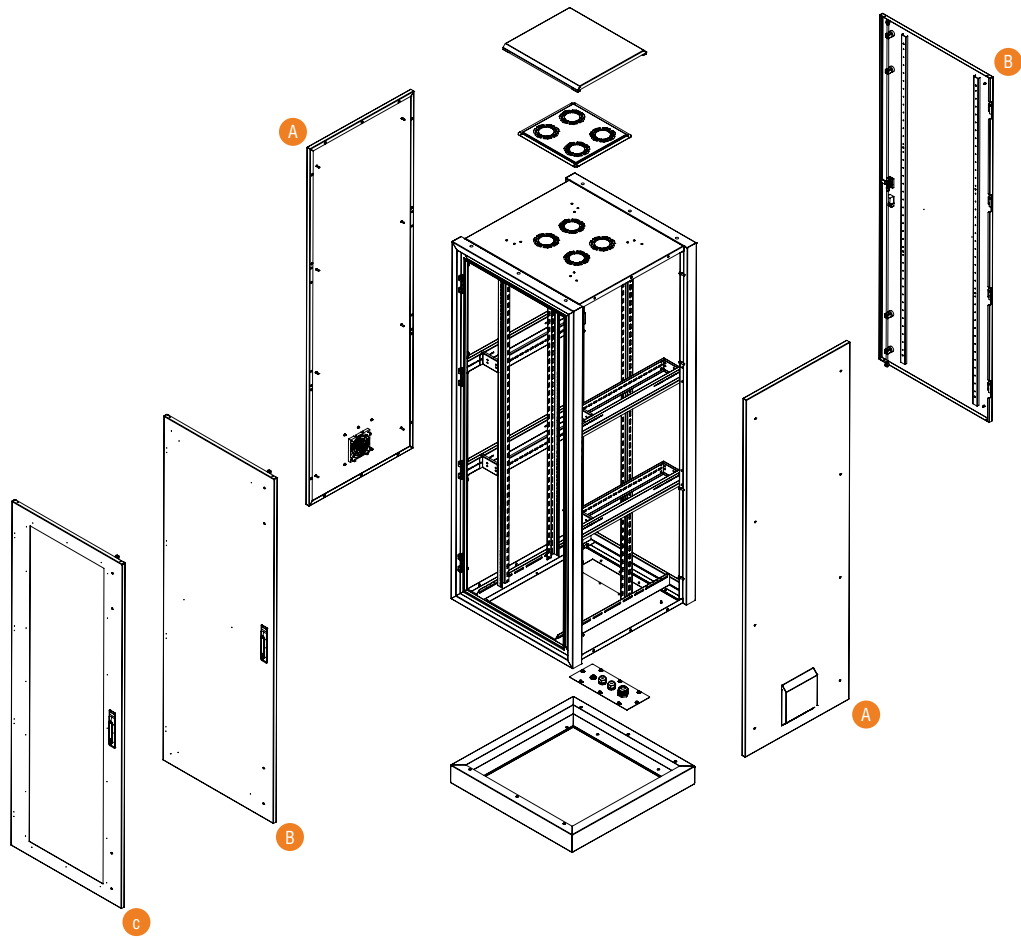

AG	IP55	42U	66	60	XX	C	B	A	A	A	M1
1	2	3	4	5	6	7	8	9	10	11	12

1. Company product coding system's initial character is AG that stands for AGER.

2. Product Series Code. AB stands for Agena Base Wall Mounted.

3. Numeric Character defining the height of the cabinet. Depending on model differences, between 07 to 20 height variety available. U Height Alphanumeric Notation is fixed, not editable. 1U is 44.45mm.

4. The First two Digits of the width information. 60 for W:600mm cabinets.

5. The First two Digits of the depth information, 45 for D:450mm cabinets, 60 for D:600mm cabinets.

6. Colour Codes. B1 for Light Gray RAL 7035. S1 for Black RAL 9005.

7. Front door variation number.\*

8. Rear door variation number\*

9. Right Side Panel variation number.\*

10. Left Side Panel variation number..

11. Version information. A- Standart version. The version is changed alphabetically when any alteration made to the cabinet

12. Indicate how the cabinets' shipped. M1 for assembled, D1 for flat pack.

\* YOU CAN CHECK THE DOOR OPTIONS FOR DOOR AND PANEL VARITIONS...

#### INDOOR IP55 Series Door Options

A Single Opening, Flat Shaped,Solid Metal, Screwed, Panel

B Single Opening, Flat Shaped, Complete Solid Metal Front Door,3 Point Locking with Handle

C Single Opening, Flat Shaped, Glass Front Door with Metal Frame, 3 Point Locking with Handle

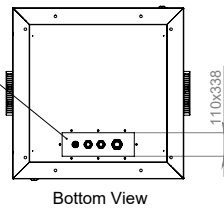
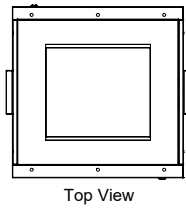
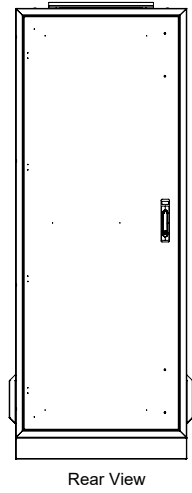
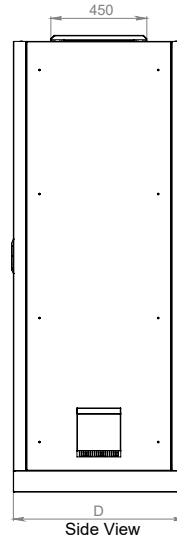
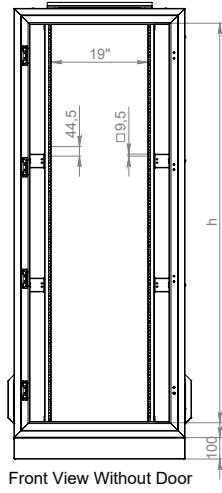
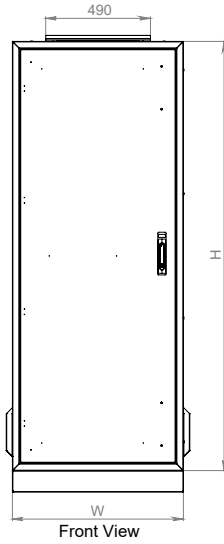

1x PG29  
2x PG21  
1x Ø28 Blind cap

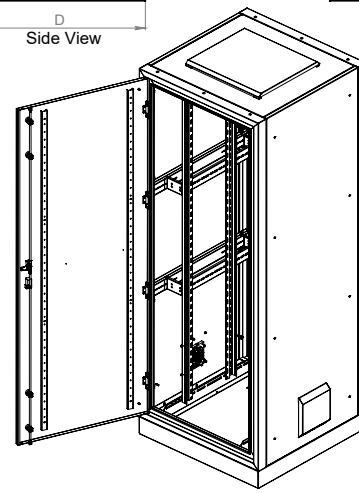
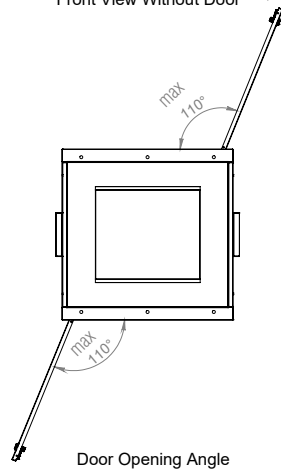

19" AGER INDOOR IP55 CABINETS

Product Code	Product Description	Height Size in U	Width (w) (mm)	Depth (D) (mm)	Height (H) (mm)	Weight (Net) (kg)	Weight (Gross) (kg)
AG-IP5522U6660XX-BBAA-A-YY	22U 19" Ager INDOOR IP55 Cabinets	22U	660	600	1119	82	86
AG-IP5526U6660XX-BBAA-A-YY	26U 19" Ager INDOOR IP55 Cabinets	26U	660	600	1296	91	95
AG-IP5532U6660XX-BBAA-A-YY	32U 19" Ager INDOOR IP55 Cabinets	32U	660	600	1563	105	109
AG-IP5536U6660XX-BBAA-A-YY	36U 19" Ager INDOOR IP55 Cabinets	36U	660	600	1741	115	119
AG-IP5542U6660XX-BBAA-A-YY	42U 19" Ager INDOOR IP55 Cabinets	42U	660	600	2008	130	134
AG-IP5522U6680XX-BBAA-A-YY	22U 19" Ager INDOOR IP55 Cabinets	22U	660	800	1119	87	91
AG-IP5526U6680XX-BBAA-A-YY	26U 19" Ager INDOOR IP55 Cabinets	26U	660	800	1296	98	102
AG-IP5532U6680XX-BBAA-A-YY	32U 19" Ager INDOOR IP55 Cabinets	32U	660	800	1563	115	119
AG-IP5536U6680XX-BBAA-A-YY	36U 19" Ager INDOOR IP55 Cabinets	36U	660	800	1741	127	131
AG-IP5542U6680XX-BBAA-A-YY	42U 19" Ager INDOOR IP55 Cabinets	42U	660	800	2008	145	149
AG-IP5522U6610XX-BBAA-A-YY	22U 19" Ager INDOOR IP55 Cabinets	22U	660	1000	1119	98	102
AG-IP5526U6610XX-BBAA-A-YY	26U 19" Ager INDOOR IP55 Cabinets	26U	660	1000	1296	110	114
AG-IP5532U6610XX-BBAA-A-YY	32U 19" Ager INDOOR IP55 Cabinets	32U	660	1000	1563	128	132
AG-IP5536U6610XX-BBAA-A-YY	36U 19" Ager INDOOR IP55 Cabinets	36U	660	1000	1741	141	145
AG-IP5542U6610XX-BBAA-A-YY	42U 19" Ager INDOOR IP55 Cabinets	42U	660	1000	2008	160	164
AG-IP5522U8080XX-BBAA-A-YY	22U 19" Ager INDOOR IP55 Cabinets	22U	800	800	1142	90	94
AG-IP5526U8080XX-BBAA-A-YY	26U 19" Ager INDOOR IP55 Cabinets	26U	800	800	1320	104	108
AG-IP5532U8080XX-BBAA-A-YY	32U 19" Ager INDOOR IP55 Cabinets	32U	800	800	1587	126	130
AG-IP5536U8080XX-BBAA-A-YY	36U 19" Ager INDOOR IP55 Cabinets	36U	800	800	1765	141	145
AG-IP5542U8080XX-BBAA-A-YY	42U 19" Ager INDOOR IP55 Cabinets	42U	800	800	2037	164	168
AG-IP5522U8010XX-BBAA-A-YY	22U 19" Ager INDOOR IP55 Cabinets	22U	800	1000	1142	104	108
AG-IP5526U8010XX-BBAA-A-YY	26U 19" Ager INDOOR IP55 Cabinets	26U	800	1000	1320	119	123
AG-IP5532U8010XX-BBAA-A-YY	32U 19" Ager INDOOR IP55 Cabinets	32U	800	1000	1587	141	145
AG-IP5536U8010XX-BBAA-A-YY	36U 19" Ager INDOOR IP55 Cabinets	36U	800	1000	1765	157	161
AG-IP5542U8010XX-BBAA-A-YY	42U 19" Ager INDOOR IP55 Cabinets	42U	800	1000	2032	180	184

XX = Colour Code, B1 White RAL 7035, S1 Black RAL 9005, during order please specify the colour choice  
 Please consider when used levelling feet 30mm add to Height, in castor add 80mm  
 0000 = Please check the Door Options page  
 YY = M1 for pre-assembled, D1 for flat pack



### Double Wall Structure

---

Double-walled and insulated structure provides high protection against accidental contact, vandalism, extreme thermal conditions and environmental impact. The outer wall is 1.5mm and the inner wall is 1.0mm, both of them DX51D+ZN275 galvanized steel. Considering environmental conditions and impact; double-walled, 9mm polyurethane thermal insulation material is used in the cabinets. This insulated structure is an effective solution to extreme weather conditions. Through ventilation slots on the forehead of the cabinet cold, fresh air enters and fans are discharge the air. Thus decrease the temperature inside the cabinet prevents heat which may damage the active devices.

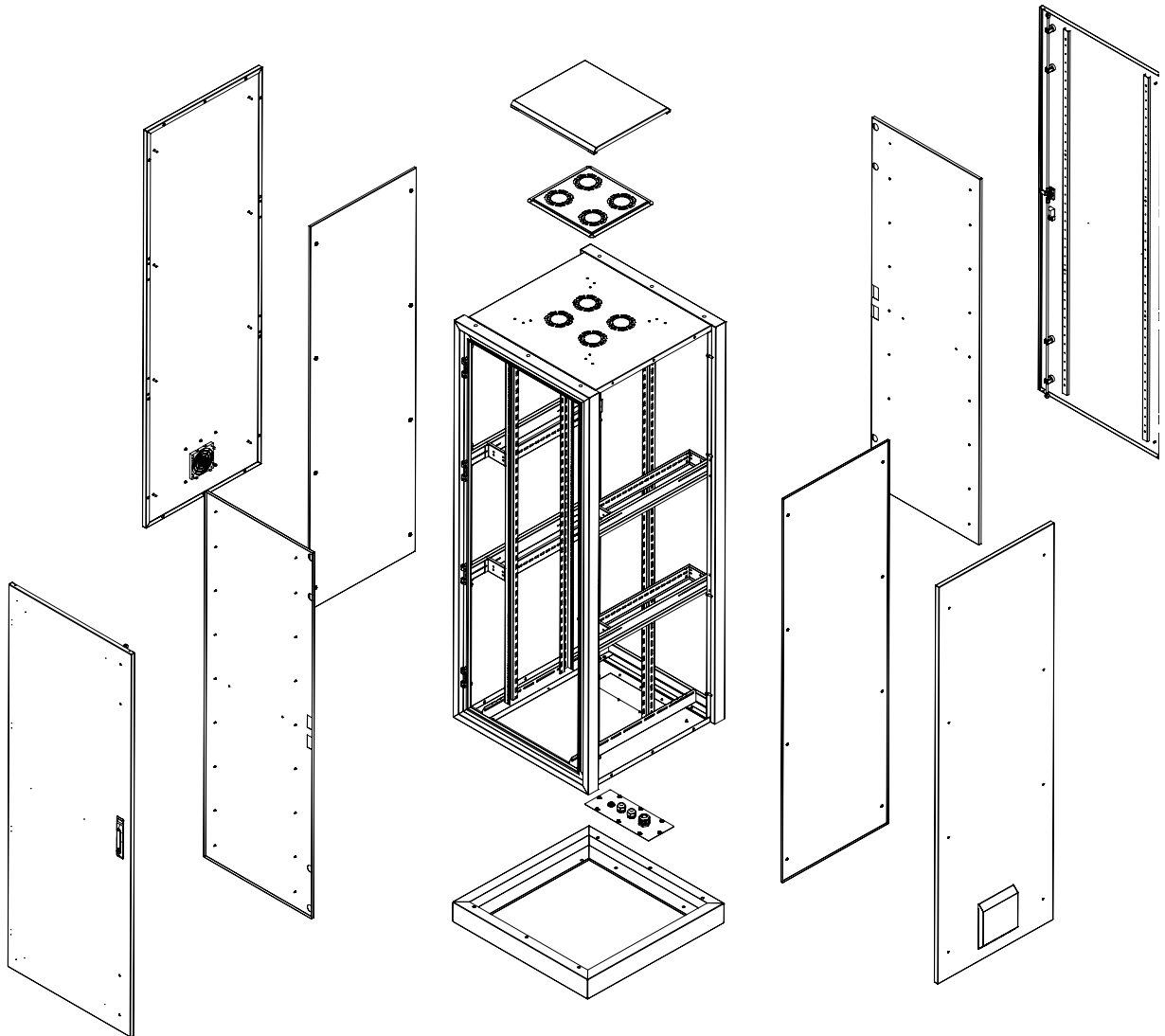

#### Material

- 1.5 mm GLV

#### IP Classification

- As a standard IP55

#### Color Options

- RAL9005 Black
- RAL7035 White

#### Loading Capacity

- Recommended up to 1500 kg Loading capacity

#### Doors

- Complete metal and complete metal framed glass door options are available.
- 3 point locking system
- Doors can be opened to 110 degree
- Doors can be opened to left or right direction

#### Mountaing Rails

- 1.5mm DX51D galvanic
- 19" Mounting rails; adjustable in depth of the cabinet

#### Side Panels

- Standard side panels are internally screwed. Locking system is available, Side panels are removable.

#### Bottom

- There is a Gland mounted panel on the bottom cover. Special work can be done upon request.

#### Ground contact

- Plinth is available as an option

#### Top Sheet

- Fan module can be mounted. Top cover canopy system allows to Air passage

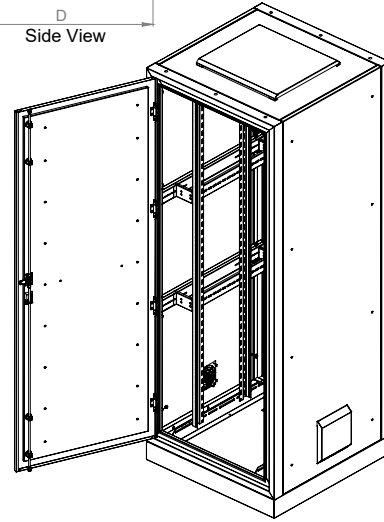
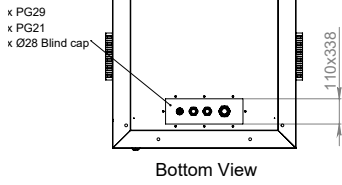
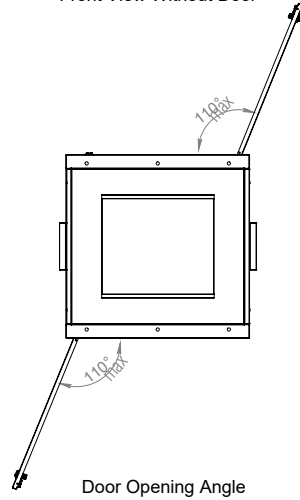
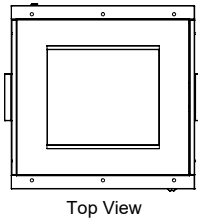
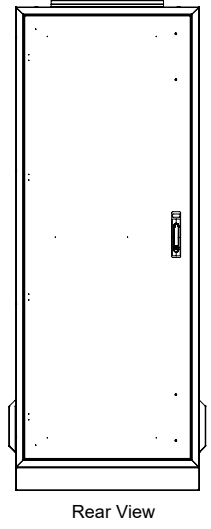
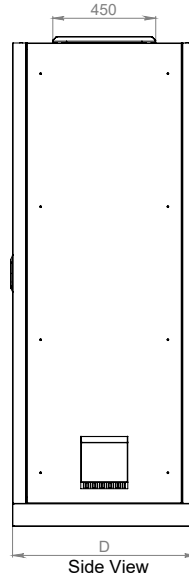
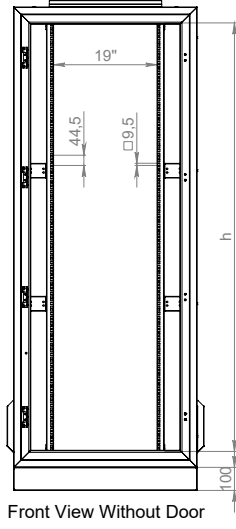
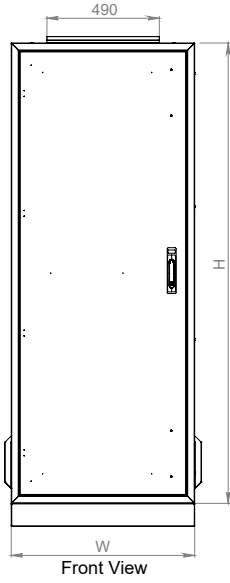

19" AGER INDOOR WALLED IP55 CABINETS

Product Code	Product Description	Height Size in U	Width (w) (mm)	Depth (D) (mm)	Height (H) (mm)	Weight (Net) (kg)	Weight (Gross) (kg)
AG-IP55D22U6660XX-BBAA-A-YY	22U 19" Ager INDOOR Walled IP55 Cabinets	22U	660	600	1119	103	107
AG-IP55D26U6660XX-BBAA-A-YY	26U 19" Ager INDOOR Walled IP55 Cabinets	26U	660	600	1296	114	118
AG-IP55D32U6660XX-BBAA-A-YY	32U 19" Ager INDOOR Walled IP55 Cabinets	32U	660	600	1563	132	136
AG-IP55D36U6660XX-BBAA-A-YY	36U 19" Ager INDOOR Walled IP55 Cabinets	36U	660	600	1741	145	149
AG-IP55D42U6660XX-BBAA-A-YY	42U 19" Ager INDOOR Walled IP55 Cabinets	42U	660	600	2008	164	168
AG-IP55D22U6680XX-BBAA-A-YY	22U 19" Ager INDOOR Walled IP55 Cabinets	22U	660	800	1119	110	114
AG-IP55D26U6680XX-BBAA-A-YY	26U 19" Ager INDOOR Walled IP55 Cabinets	26U	660	800	1296	125	129
AG-IP55D32U6680XX-BBAA-A-YY	32U 19" Ager INDOOR Walled IP55 Cabinets	32U	660	800	1563	147	151
AG-IP55D36U6680XX-BBAA-A-YY	36U 19" Ager INDOOR Walled IP55 Cabinets	36U	660	800	1741	162	166
AG-IP55D42U6680XX-BBAA-A-YY	42U 19" Ager INDOOR Walled IP55 Cabinets	42U	660	800	2008	185	189
AG-IP55D22U6610XX-BBAA-A-YY	22U 19" Ager INDOOR Walled IP55 Cabinets	22U	660	1000	1119	128	132
AG-IP55D26U6610XX-BBAA-A-YY	26U 19" Ager INDOOR Walled IP55 Cabinets	26U	660	1000	1296	143	147
AG-IP55D32U6610XX-BBAA-A-YY	32U 19" Ager INDOOR Walled IP55 Cabinets	32U	660	1000	1563	165	169
AG-IP55D36U6610XX-BBAA-A-YY	36U 19" Ager INDOOR Walled IP55 Cabinets	36U	660	1000	1741	181	185
AG-IP55D42U6610XX-BBAA-A-YY	42U 19" Ager INDOOR Walled IP55 Cabinets	42U	660	1000	2008	204	208
AG-IP55D22U8080XX-BBAA-A-YY	22U 19" Ager INDOOR Walled IP55 Cabinets	22U	800	800	1142	115	119
AG-IP55D26U8080XX-BBAA-A-YY	26U 19" Ager INDOOR Walled IP55 Cabinets	26U	800	800	1320	133	137
AG-IP55D32U8080XX-BBAA-A-YY	32U 19" Ager INDOOR Walled IP55 Cabinets	32U	800	800	1587	161	165
AG-IP55D36U8080XX-BBAA-A-YY	36U 19" Ager INDOOR Walled IP55 Cabinets	36U	800	800	1765	180	184
AG-IP55D42U8080XX-BBAA-A-YY	42U 19" Ager INDOOR Walled IP55 Cabinets	42U	800	800	2037	208	212
AG-IP55D22U8010XX-BBAA-A-YY	22U 19" Ager INDOOR Walled IP55 Cabinets	22U	800	1000	1142	136	140
AG-IP55D26U8010XX-BBAA-A-YY	26U 19" Ager INDOOR Walled IP55 Cabinets	26U	800	1000	1320	155	159
AG-IP55D32U8010XX-BBAA-A-YY	32U 19" Ager INDOOR Walled IP55 Cabinets	32U	800	1000	1587	181	185
AG-IP55D36U8010XX-BBAA-A-YY	36U 19" Ager INDOOR Walled IP55 Cabinets	36U	800	1000	1765	201	205
AG-IP55D42U8010XX-BBAA-A-YY	42U 19" Ager INDOOR Walled IP55 Cabinets	42U	800	1000	2032	230	234

XX = Colour Code, B1 White RAL 7035, S1 Black RAL 9005, during order please specify the colour choice  
 Please consider when used levelling feet 30mm add to Height, in castor add 80mm  
 0000 = Please check the Door Options page  
 YY = M1 for pre-assembled, D1 for flat pack