

FREE STANDING **SERVER** SERIES

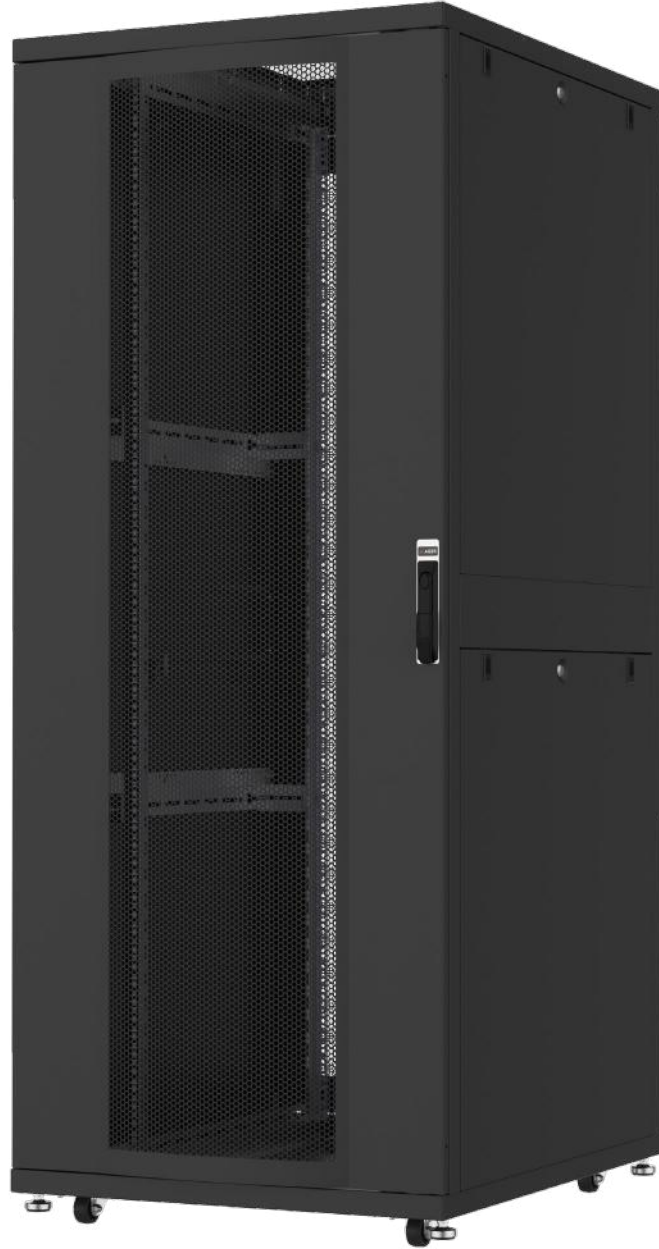

SERVER series cabinets reach the maximum strength with 90-degree vertical profiles fixed to special design monoblock welded bottom frame with steel screws. It is an ideal solution for your heavy equipment with up to 1500kg loading capacity.



Color Options

RAL7035 Light Grey

RAL9005 Black



Cabinet Structure

The cabinets could be mounted side by side. They are network and server cabinets; suitable for office, system room, data centre, and cabling system installation. Compatible for all kind of 19" brands and models network and server equipments

During installation and while conducting routine maintenance and repair of installed equipment; removable side panels, rear door and the top plate allows to multiple easy access. Optimum depth for comfort cabling, server housing and equipment in the cabinets

Side panels, Front and rear doors are lockable and accessible with the same key. Front and rear doors could be detached and reversed to allow the door to open from the rear of the cabinet.

Bottom Cable Entry

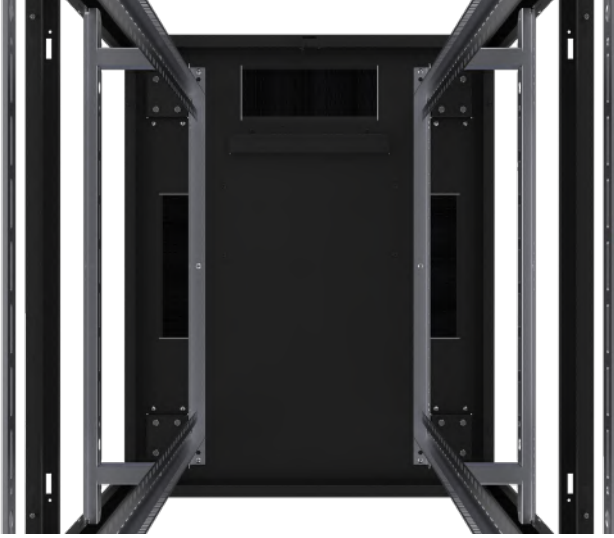

600-width cabinets' bottom plate has a 120*300mm brushed cable entry point and 250*300 slide cable entry hall with rubber edge. In 800-width cabinets; in addition to the 600-width standard cabinets, the bottom plate of the cabinet has two 70mm * 316mm sized brushed cable entry holes placed on the right and left side. Sliding cable entry hall with rubber edge allows the maximum cable entries to the cabinet without any damaged and ensures protection against dust and substances ingress.

Top Cable Entry

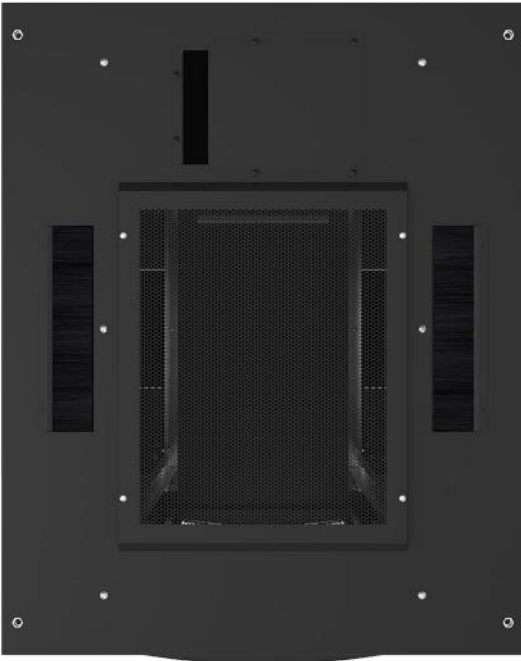

600-width cabinets' have a 175mm *250mm sliding cable entry hall with rubber edge entry at the top plate which is located center of the rear. In 800-width cabinets; in addition to the 600-width standard cabinets, the top plate of the cabinet has two 70mm * 316mm sized brushed cable entry holes placed on the right and left side. Sliding cable entry hall with rubber edge allows the maximum cable entries to the cabinet without any damaged and ensures protection against dust and substances ingress.



Side Panels

The top and bottom side panel model of SERVER series cabinets allows easy removal of side panels during assembly, maintenance and repair. The cylinder locking mechanism is used on the panels.



Castors and Pinion Feet

Four heavy duty levelling feet and 4 castors without brake mounted to the bottom corner of the cabinet helps to adjust cabinet height and stability according to the ground condition.



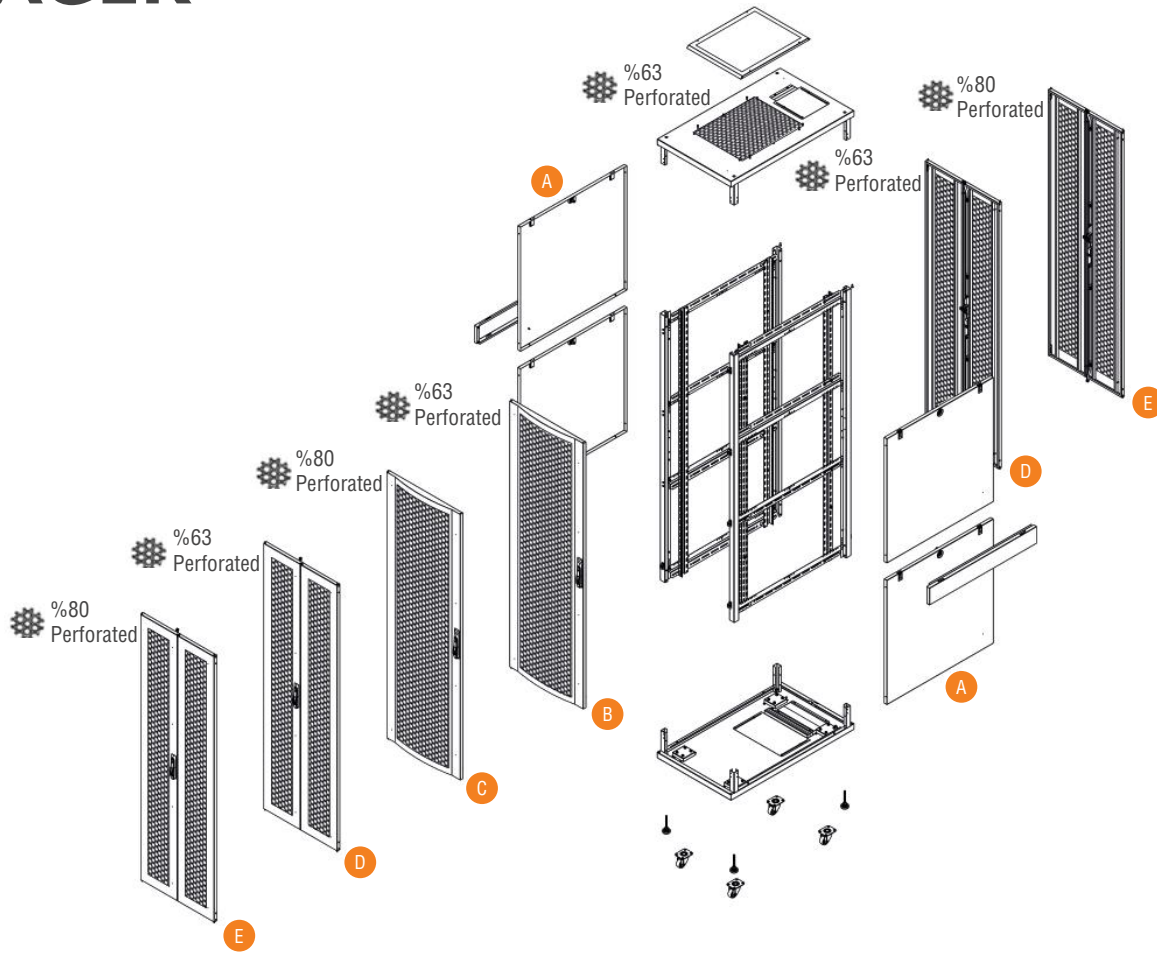

AG	SR	42U	60	10	S1	B	D	A	A	A	M1
1	2	3	4	5	6	7	8	9	10	11	12

1. Company product coding system's initial character is AG that stands for AGER.
2. Product Series Code. SR stands for SERVER Free-Standing,
3. Numeric Character defining the height of the cabinet. Depending on model differences, between 42 to 47 height variety available. U Height Alphanumeric Notation is fixed, not editable. 1U is 44.45mm.
4. The First two Digits of the width information. 60 for W:600mm cabinets
5. The First two Digits of the depth information, 10 for D:1000mm cabinets, 11 for D:1100mm cabinets, 12 for D:1200mm cabinets
6. Colour Codes. B1 for Light Gray RAL 7035. S1 for Black RAL 9005.
7. Front door variation number.*
8. Rear door variation number*
9. Right Side Panel variation number.*
10. Left Side Panel variation number..
11. Version information. A- Standart version. The version is changed alphabetically when any alteration made to the cabinet
12. Indicate how the cabinets' shipped. M1 for assembled, D1 for flat pack.

* YOU CAN CHECK THE DOOR OPTIONS FOR DOOR AND PANEL VARIATIONS...

Free Standing SERVER Series DOOR Options

- A Double Opening, Flat Shaped, Solid Metal, Sliding Locking and Single point Locking, Panel.
- B Single Opening, Curved Shaped, Complete Framed %63 Perforated, Metal Front Door, Four Point Locking with Handle.
- C Single Opening, Curved Shaped, Complete Framed %80 Perforated, Metal Front Door, Four Point Locking with Handle.
- D Double Opening, Flat Shaped, Complete Framed %63 Perforated, Metal Front and Rear Door, 3 Point Locking with Handle and Hinges
- E Double Opening, Flat Shaped, Complete Framed %80 Perforated, Metal Front and Rear Door, 3 Point Locking with Handle and Hinges

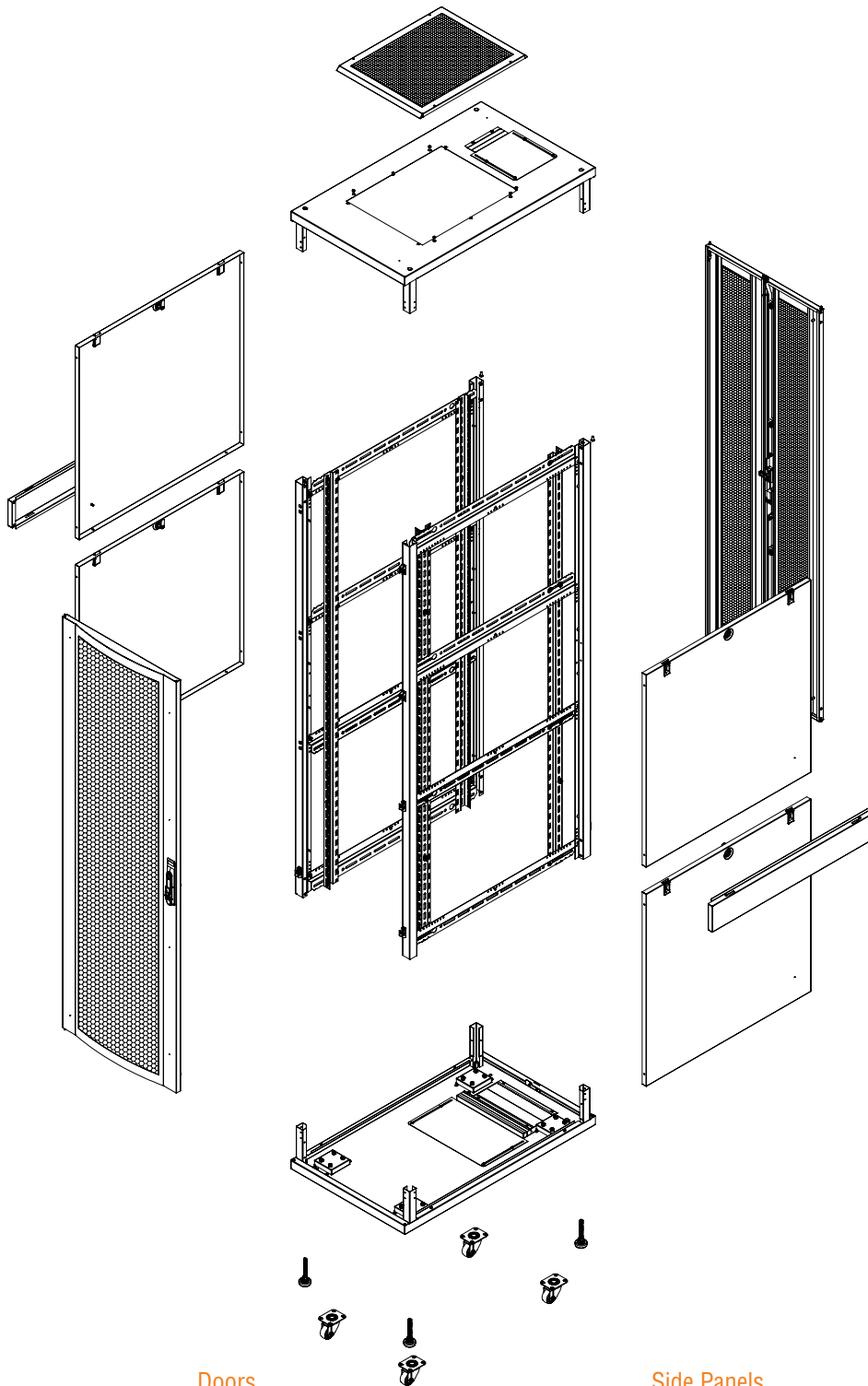

Material

- 1.5 mm DKP

IP Classification

- As a standard IP20
- IP40 when solid metal panel applied for all access

Color Options

- RAL9005 Black
- RAL7035 White

Doors

- Door options are available.
- Front door 4 and rear door 3 point locking systems
- Doors can be opened to 230 degree.
- Doors can be opened to left or right direction

Mounting Rails

- 19" Mounting rails; adjustable in depth of the cabinet
- 1.5mm DX51D galvanic

Side Panels

- Locking system is available, Side panels are removable.

Loading Capacity

- Recommended up to 1500 kg Loading capacity

Ground contact

- Caster and levelling feet are included to standard configuration
- Plinth is available as an option.

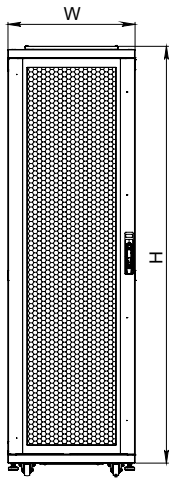

FRONT VIEW

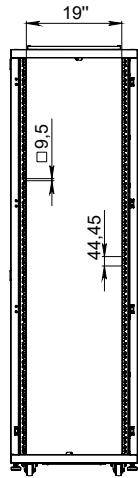

FRONT VIEW WITHOUT DOOR

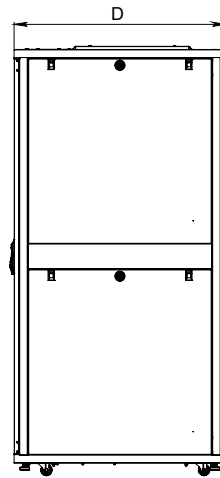

SIDE VIEW

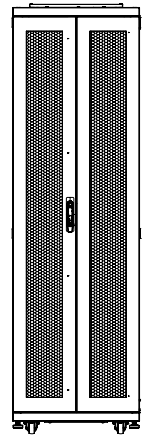

REAR VIEW

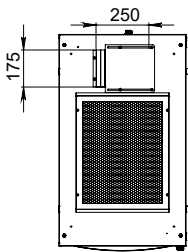

TOP VIEW

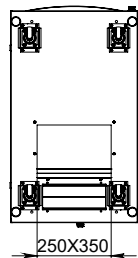

BOTTOM VIEW

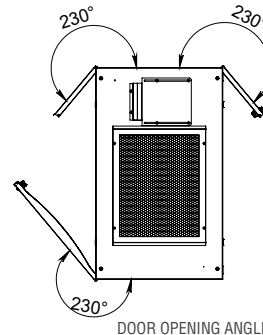

DOOR OPENING ANGLE

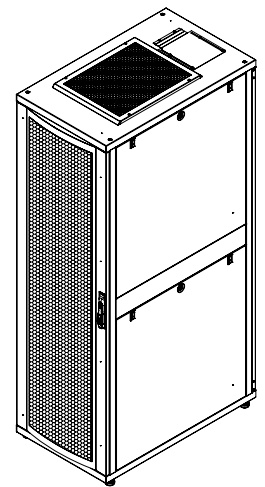

ISOMETRIC VIEW

19" Ager Free Standing Server Cabinets W=600mm D=1000mm

Product Code	Product Description	Height Size in U	Width (w) (mm)	Depth (D) (mm)	Height (H) (mm)	Weight (Net) (kg)	Weight (Gross) (kg)
AG-SR24U6010XX-0000-A-YY	24U 19" Ager Free Standing Server Cabinets W=600mm D=1000mm	24U	600	1000	1173	64,6	78,6
AG-SR26U6010XX-0000-A-YY	26U 19" Ager Free Standing Server Cabinets W=600mm D=1000mm	26U	600	1000	1261	70	84
AG-SR32U6010XX-0000-A-YY	32U 19" Ager Free Standing Server Cabinets W=600mm D=1000mm	32U	600	1000	1527	86,4	100,2
AG-SR36U6010XX-0000-A-YY	36U 19" Ager Free Standing Server Cabinets W=600mm D=1000mm	36U	600	1000	1704	97,2	111
AG-SR42U6010XX-0000-A-YY	42U 19" Ager Free Standing Server Cabinets W=600mm D=1000mm	42U	600	1000	1970	114	131
AG-SR45U6010XX-0000-A-YY	45U 19" Ager Free Standing Server Cabinets W=600mm D=1000mm	45U	600	1000	2103	121	138
AG-SR47U6010XX-0000-A-YY	47U 19" Ager Free Standing Server Cabinets W=600mm D=1000mm	47U	600	1000	2192	127	144

XX = Colour Code, B1 White RAL 7035, S1 Black RAL 9005, during order please specify the colour choice
Please consider when used levelling feet 30mm add to height, in castor add 80mm.

0000 = Please check the Door Options page.
YY = M1 for pre-assembled, D1 for flat pack.

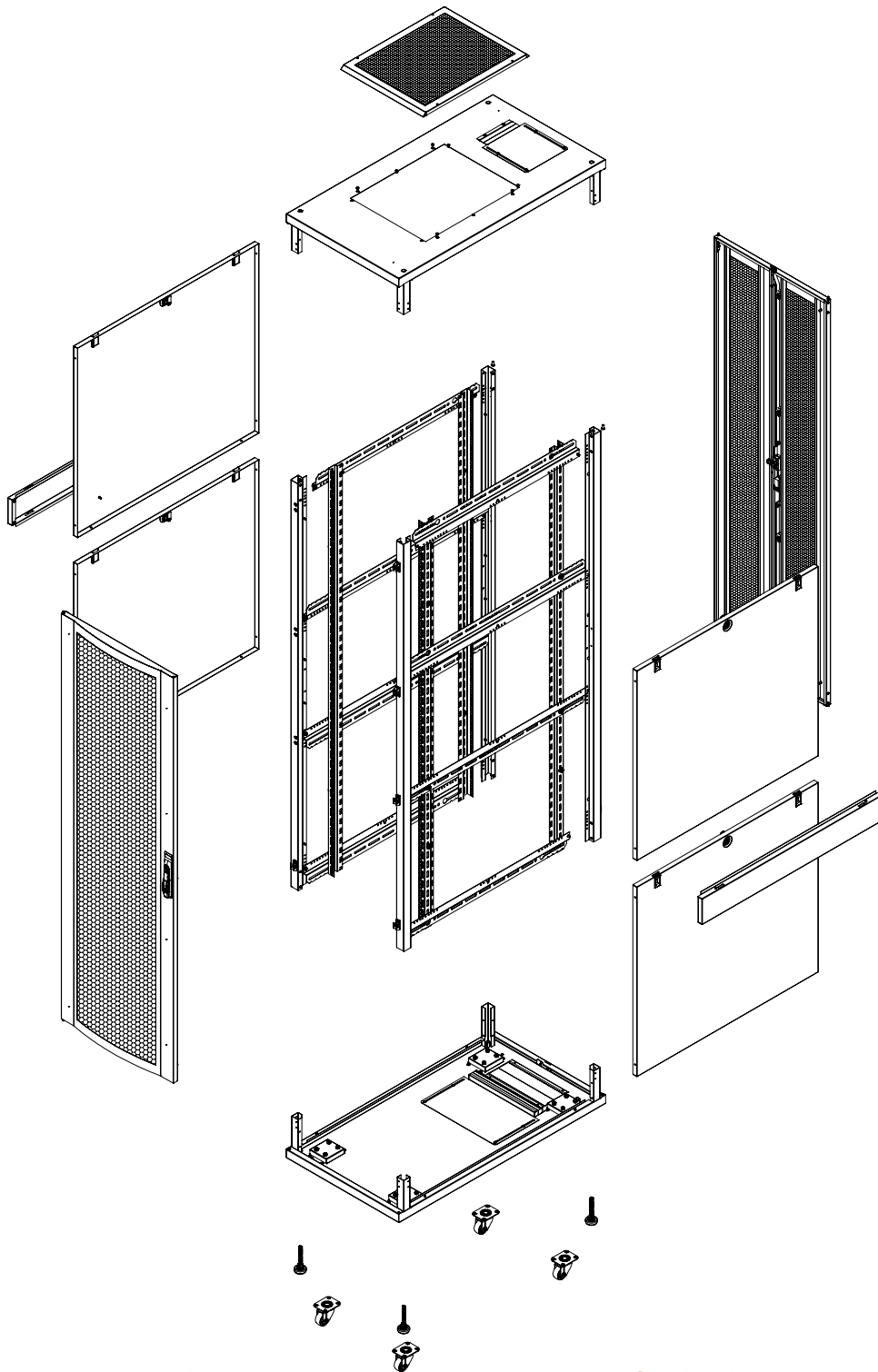

Material

- 1.5 mm DKP

IP Classification

- As a standard IP20
- IP40 when solid metal panel applied for all access

Color Options

- RAL9005 Black
- RAL7035 White

Doors

- Door options are available.
- Front door 4 and rear door 3 point locking systems
- Doors can be opened to 230 degree.
- Doors can be opened to left or right direction

Mounting Rails

- 19" Mounting rails; adjustable in depth of the cabinet
- 1.5mm DX51D galvanic

Side Panels

- Locking system is available, Side panels are removable.

Loading Capacity

- Recommended up to 1500 kg Loading capacity

Ground contact

- Caster and levelling feet are included to standard configuration
- Plinth is available as an option.

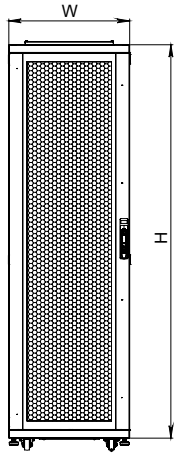

FRONT VIEW

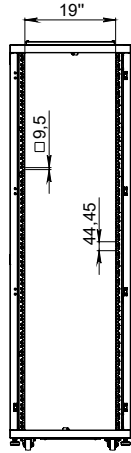

FRONT VIEW WITHOUT DOOR

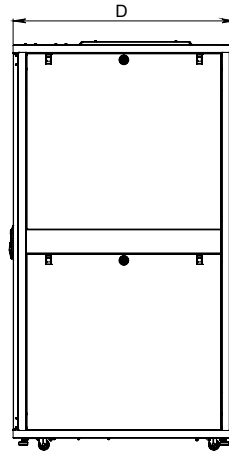

SIDE VIEW

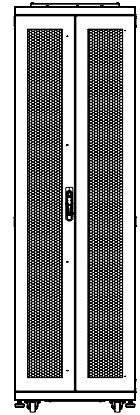

REAR VIEW

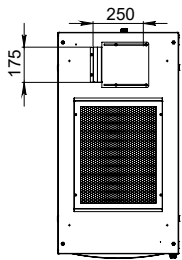

TOP VIEW

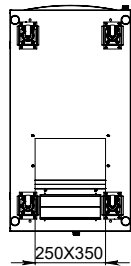

BOTTOM VIEW

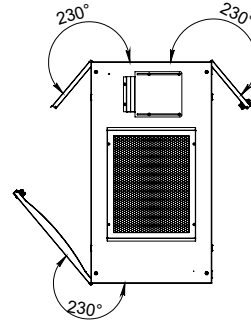

DOOR OPENING ANGLE

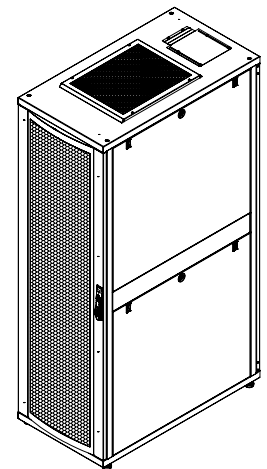

ISOMETRIC VIEW

19" Ager Free Standing Server Cabinets W=600mm D=1100mm

Product Code	Product Description	Height Size in U	Width (w) (mm)	Depth (D) (mm)	Height (H) (mm)	Weight (Net) (kg)	Weight (Gross) (kg)
AG-SR24U6011XX-0000-A-YY	24U 19" Ager Free Standing Server Cabinets W=600mm D=1100mm	24U	600	1100	1173	73,6	87,6
AG-SR26U6011XX-0000-A-YY	26U 19" Ager Free Standing Server Cabinets W=600mm D=1100mm	26U	600	1100	1261	78,2	92,2
AG-SR32U6011XX-0000-A-YY	32U 19" Ager Free Standing Server Cabinets W=600mm D=1100mm	32U	600	1100	1527	92,2	106,2
AG-SR36U6011XX-0000-A-YY	36U 19" Ager Free Standing Server Cabinets W=600mm D=1100mm	36U	600	1100	1704	101,6	115,6
AG-SR42U6011XX-0000-A-YY	42U 19" Ager Free Standing Server Cabinets W=600mm D=1100mm	42U	600	1100	1970	115,6	129,6
AG-SR45U6011XX-0000-A-YY	45U 19" Ager Free Standing Server Cabinets W=600mm D=1100mm	45U	600	1100	2103	122,6	136,6
AG-SR47U6011XX-0000-A-YY	47U 19" Ager Free Standing Server Cabinets W=600mm D=1100mm	47U	600	1100	2192	127,2	141,2

XX = Colour Code, B1 White RAL 7035, S1 Black RAL 9005, during order please specify the colour choice

Please consider when used levelling feet 30mm add to height, in castor add 80mm.

0000 = Please check the Door Options page.

YY = M1 for pre-assembled, D1 for flat pack.

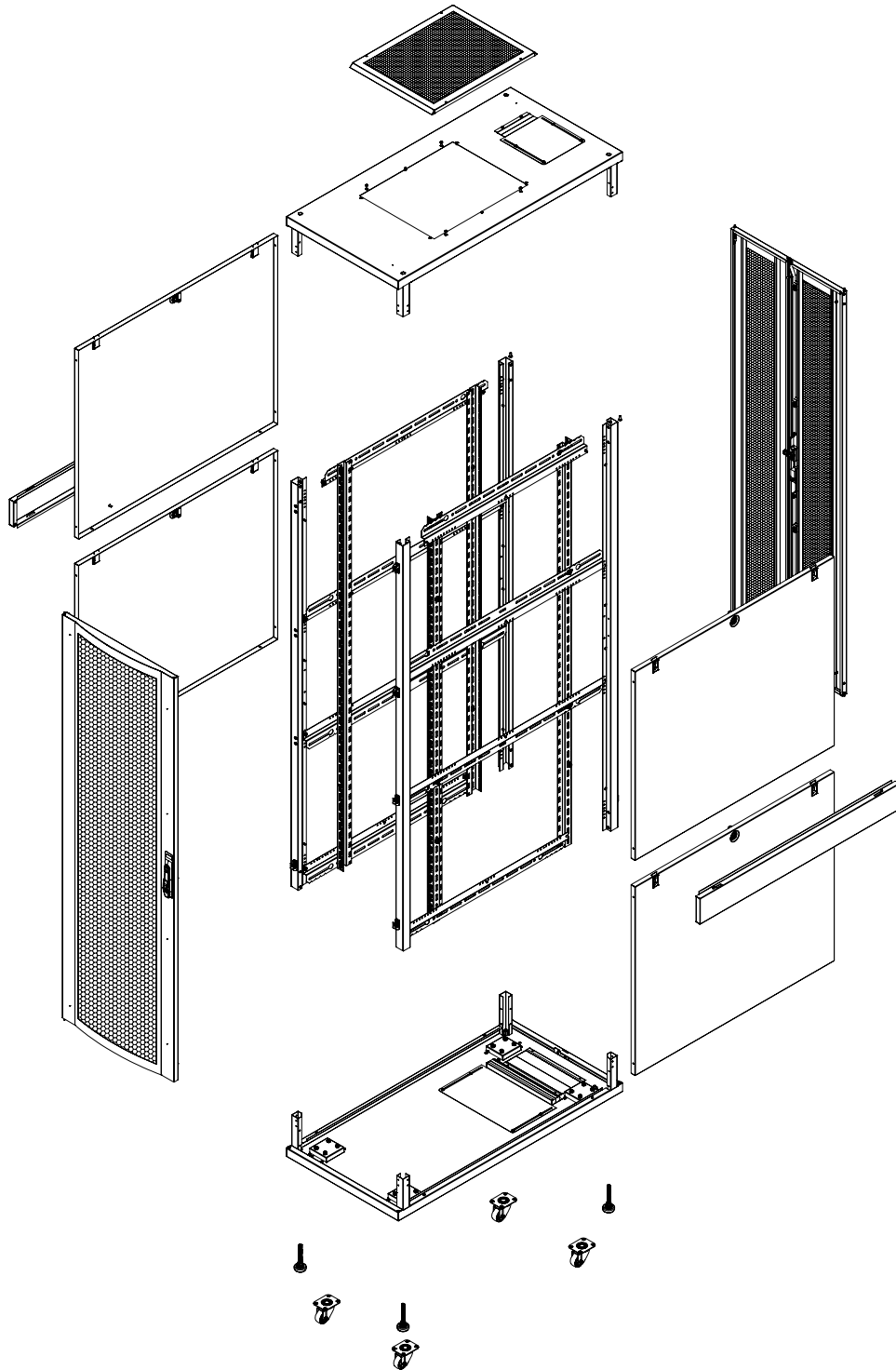

Material

- 1.5 mm DKP

IP Classification

- As a standard IP20
- IP40 when solid metal panel applied for all access

Color Options

- RAL9005 Black
- RAL7035 White

Doors

- Door options are available.
- Front door 4 and rear door 3 point locking systems
- Doors can be opened to 230 degree.
- Doors can be opened to left or right direction

Mounting Rails

- 19" Mounting rails; adjustable in depth of the cabinet
- 1.5mm DX51D galvanic

Side Panels

- Locking system is available, Side panels are removable.

Loading Capacity

- Recommended up to 1500 kg Loading capacity

Ground contact

- Caster and levelling feet are included to standard configuration
- Plinth is available as an option.

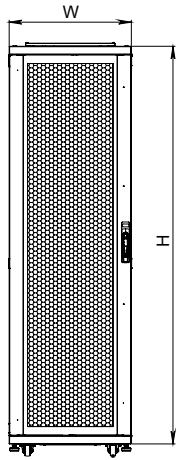

FRONT VIEW

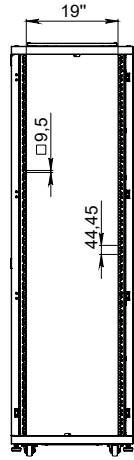

FRONT VIEW WITHOUT DOOR

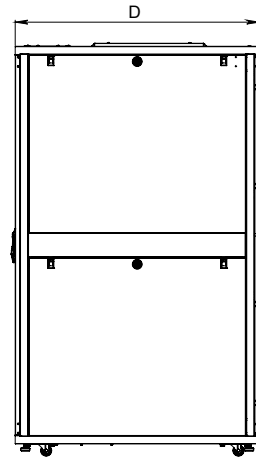

SIDE VIEW

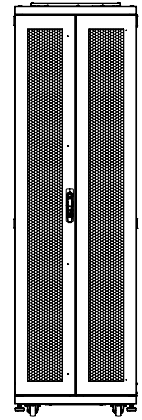

REAR VIEW

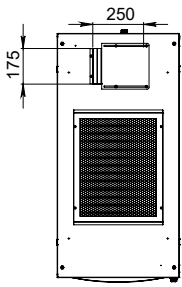

TOP VIEW

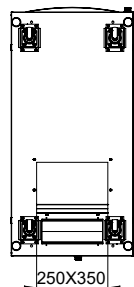

BOTTOM VIEW

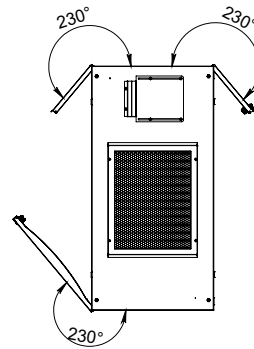

DOOR OPENING ANGLE

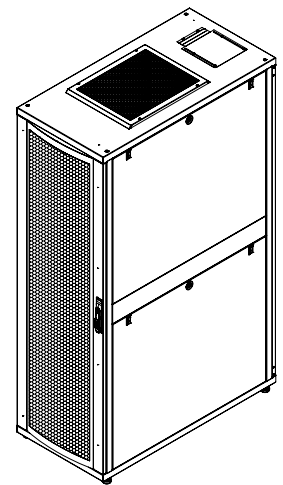

ISOMETRIC VIEW

19" Ager Free Standing Server Cabinets W=600mm D=1200mm

Product Code	Product Description	Height Size in U	Width (w) (mm)	Depth (D) (mm)	Height (H) (mm)	Weight (Net) (kg)	Weight (Gross) (kg)
AG-SR24U6012XX-0000-A-YY	24U 19" Ager Free Standing Server Cabinets W=600mm D=1200mm	24U	600	1200	1173	82,6	96,6
AG-SR26U6012XX-0000-A-YY	26U 19" Ager Free Standing Server Cabinets W=600mm D=1200mm	26U	600	1200	1261	87,2	101,2
AG-SR32U6012XX-0000-A-YY	32U 19" Ager Free Standing Server Cabinets W=600mm D=1200mm	32U	600	1200	1527	101,2	115,2
AG-SR36U6012XX-0000-A-YY	36U 19" Ager Free Standing Server Cabinets W=600mm D=1200mm	36U	600	1200	1704	110,6	124,6
AG-SR42U6012XX-0000-A-YY	42U 19" Ager Free Standing Server Cabinets W=600mm D=1200mm	42U	600	1200	1970	124,6	138,6
AG-SR45U6012XX-0000-A-YY	45U 19" Ager Free Standing Server Cabinets W=600mm D=1200mm	45U	600	1200	2103	131,6	145,6
AG-SR47U6012XX-0000-A-YY	47U 19" Ager Free Standing Server Cabinets W=600mm D=1200mm	47U	600	1200	2192	138,6	152,6

XX = Colour Code, B1 White RAL 7035, S1 Black RAL 9005, during order please specify the colour choice

Please consider when used levelling feet 30mm add to height, in castor add 80mm.

0000 = Please check the Door Options page.

YY = M1 for pre-assembled, D1 for flat pack.

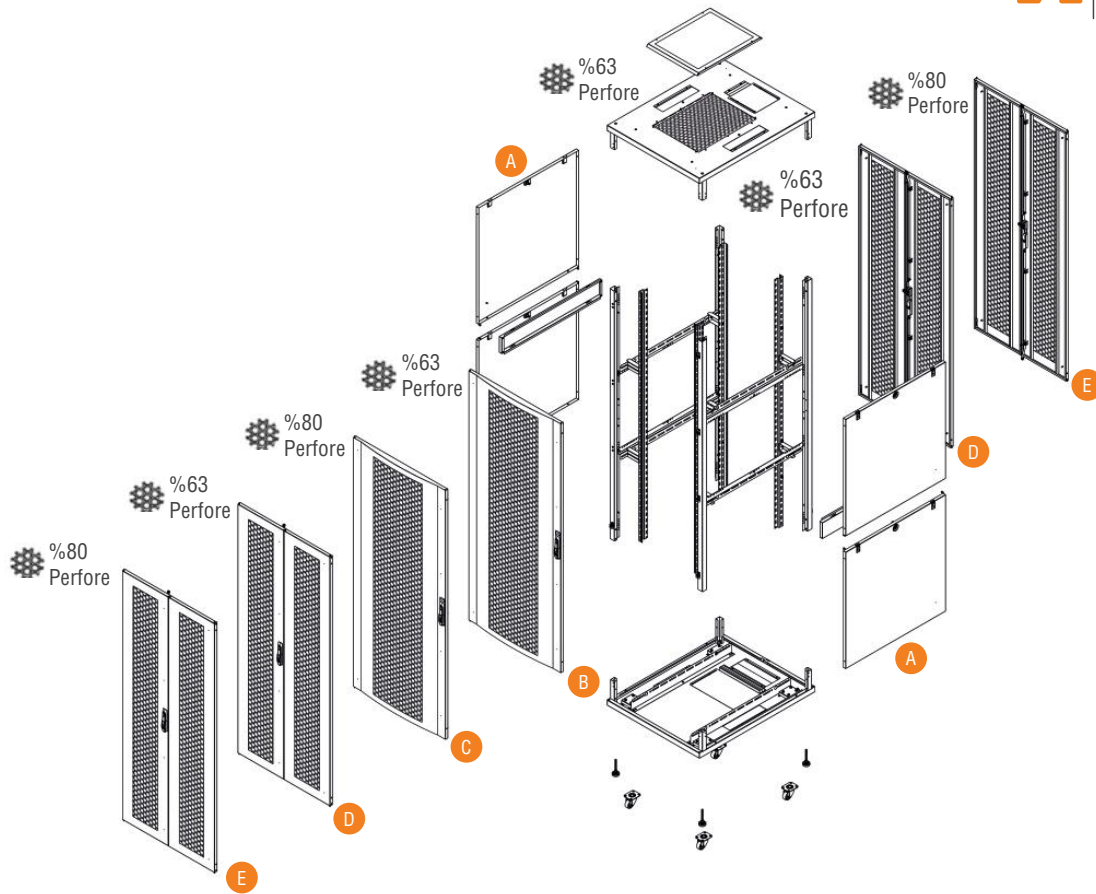

AG	VG	42U	80	10	S1	B	D	A	A	A	M1
1	2	3	4	5	6	7	8	9	10	11	12

1. Company product coding system's initial character is AG that stands for AGER.
2. Product Series Code. SR stands for SERVER Free-Standing,
3. Numeric Character defining the height of the cabinet. Depending on model differences, between 42 to 47 height variety available. U Height Alfanumeric Notation is fixed, not editable. 1U is 44.45mm.
4. The First two Digits of the width information. 60 for W:600mm cabinets
5. The First two Digits of the depth information, 10 for D:1000mm cabinets, 11 for D:1100mm cabinets, 12 for D:1200mm cabinets
6. Colour Codes. B1 for Light Gray RAL 7035. S1 for Black RAL 9005.
7. Front door variation number.*
8. Rear door variation number*
9. Right Side Panel variation number.*
10. Left Side Panel variation number..
11. Version information. A- Standart version. The version is changed alphabetically when any alteration made to the cabinet
12. Indicate how the cabinets' shipped. M1 for assembled, D1 for flat pack.

Free Standing SERVER Series DOOR Options

- A Double Opening, Flat Shaped, Solid Metal, Sliding Locking and Single point Locking, Panel.
- B Single Opening, Curved Shaped, Complete Framed %63 Perforated, Metal Front Door, Four Point Locking with Handle.
- C Single Opening, Curved Shaped, Complete Framed %80 Perforated, Metal Front Door, Four Point Locking with Handle.
- D Double Opening, Flat Shaped, Complete Framed %63 Perforated, Metal Front and Rear Door, 3 Point Locking with Handle and Hinges
- E Double Opening, Flat Shaped, Complete Framed %80 Perforated, Metal Front and Rear Door, 3 Point Locking with Handle and Hinges

* YOU CAN CHECK THE DOOR OPTIONS FOR DOOR AND PANEL VARIATIONS...

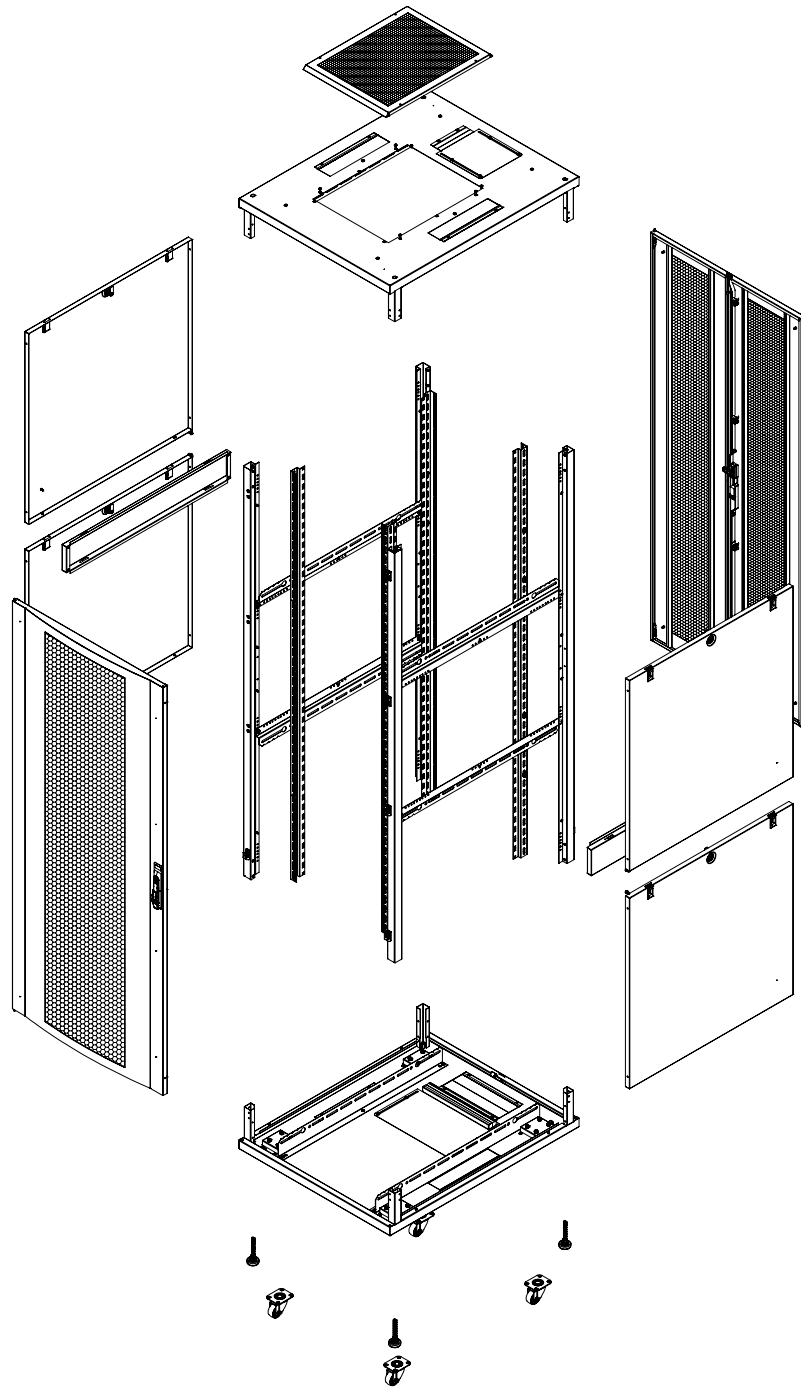

Material

- 1.5 mm DKP

IP Classification

- As a standard IP20
- IP40 when solid metal panel applied for all access

Color Options

- RAL9005 Black
- RAL7035 White

Doors

- Door options are available.
- Front door 4 and rear door 3 point locking systems
- Doors can be opened to 230 degree.
- Doors can be opened to left or right direction

Mounting Rails

- 19" Mounting rails; adjustable in depth of the cabinet
- 1.5mm DX51D galvanic

Side Panels

- Locking system is available, Side panels are removable.

Loading Capacity

- Recommended up to 1500 kg Loading capacity

Ground contact

- Caster and levelling feet are included to standard configuration
- Plinth is available as an option.

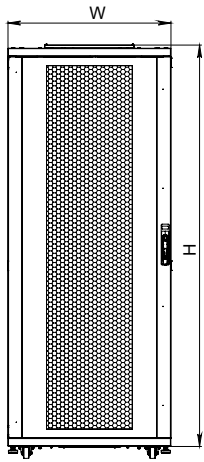

FRONT VIEW

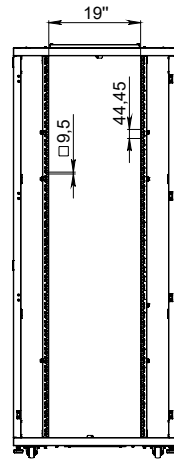

FRONT VIEW WITHOUT DOOR

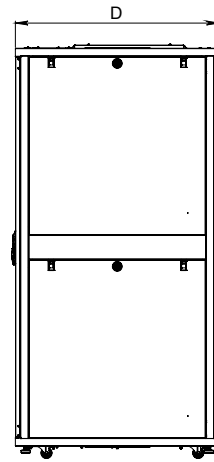

SIDE VIEW

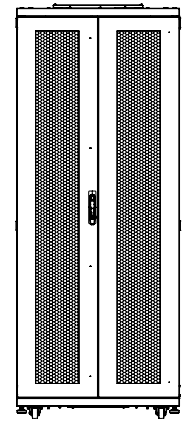

REAR VIEW

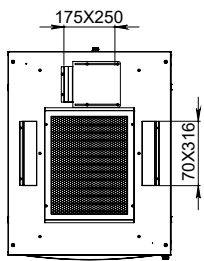

TOP VIEW

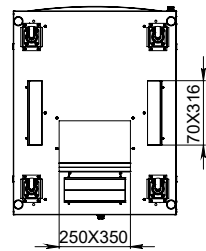

BOTTOM VIEW

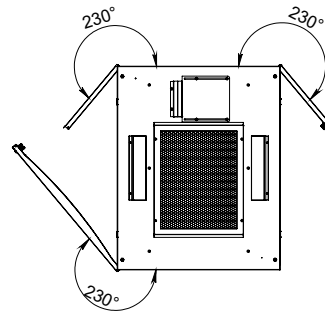

DOOR OPENING ANGLE

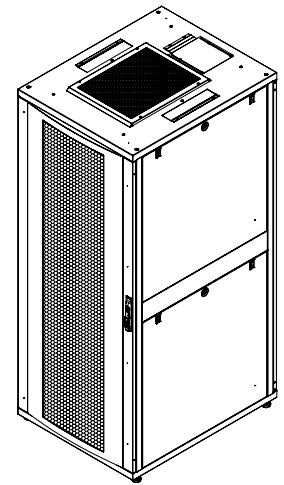

ISOMETRIC VIEW

19" Ager Free Standing Server Cabinets W=800mm D=1000mm

Product Code	Product Description	Height Size in U	Width (w) (mm)	Depth (D) (mm)	Height (H) (mm)	Weight (Net) (kg)	Weight (Gross) (kg)
AG-SR24U8010XX-0000-A-YY	24U 19" Ager Free Standing Server Cabinets W=800mm D=1000mm	24U	800	1000	1173	90,4	112,4
AG-SR26U8010XX-0000-A-YY	26U 19" Ager Free Standing Server Cabinets W=800mm D=1000mm	26U	800	1000	1261	95	117
AG-SR32U8010XX-0000-A-YY	32U 19" Ager Free Standing Server Cabinets W=800mm D=1000mm	32U	800	1000	1527	109	131
AG-SR36U8010XX-0000-A-YY	36U 19" Ager Free Standing Server Cabinets W=800mm D=1000mm	36U	800	1000	1704	118,4	140,4
AG-SR42U8010XX-0000-A-YY	42U 19" Ager Free Standing Server Cabinets W=800mm D=1000mm	42U	800	1000	1970	132,4	154,4
AG-SR45U8010XX-0000-A-YY	45U 19" Ager Free Standing Server Cabinets W=800mm D=1000mm	45U	800	1000	2103	139,4	161,4
AG-SR47U8010XX-0000-A-YY	47U 19" Ager Free Standing Server Cabinets W=800mm D=1000mm	47U	800	1000	2192	144	166

XX = Colour Code, B1 White RAL 7035, S1 Black RAL 9005, during order please specify the colour choice
 Please consider when used levelling feet 30mm add to height, in castor add 80mm.
 0000 = Please check the Door Options page.
 YY = M1 for pre-assembled, D1 for flat pack.

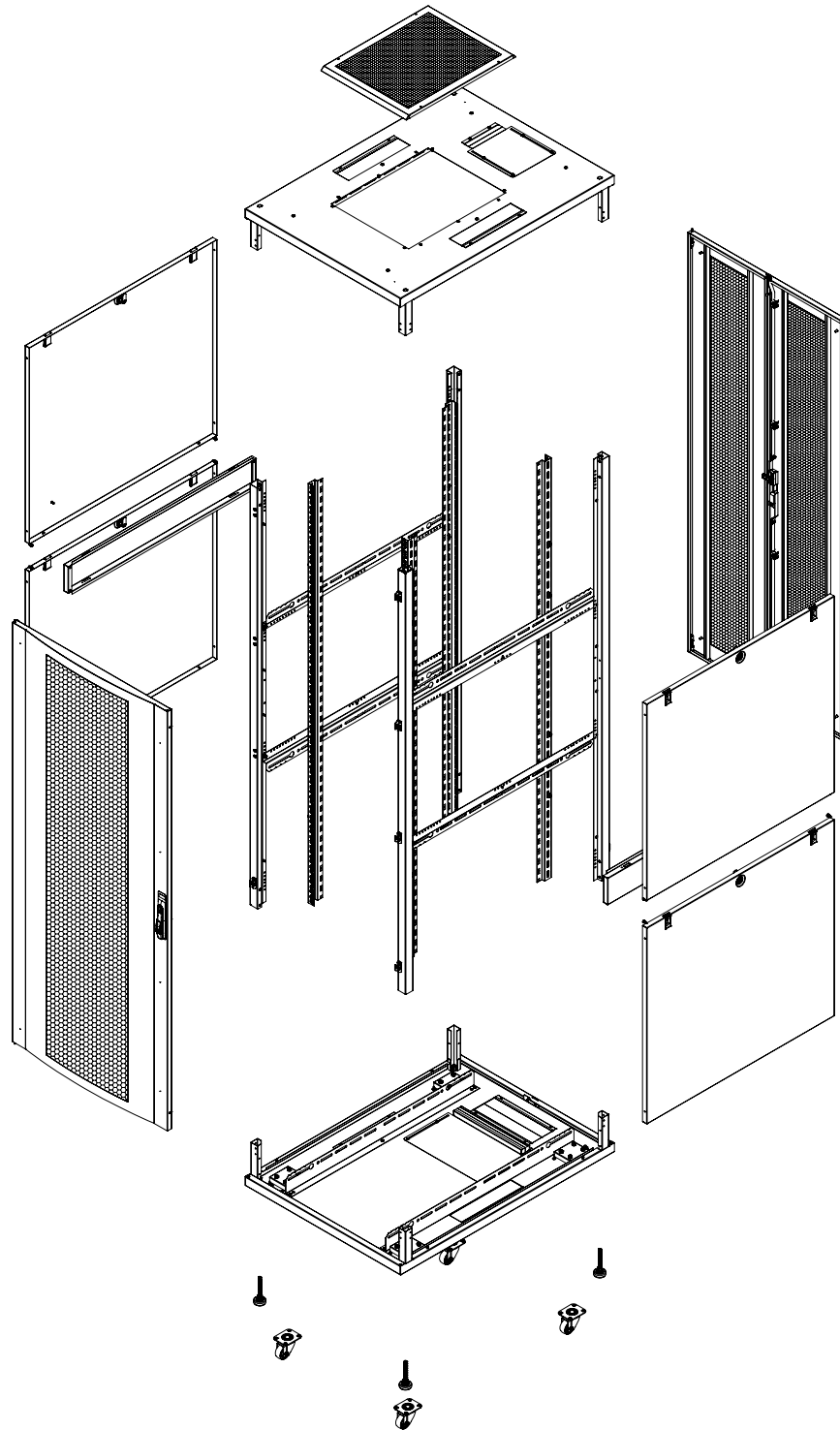

Material

- 1.5 mm DKP

IP Classification

- As a standard IP20
- IP40 when solid metal panel applied for all access

Color Options

- RAL9005 Black
- RAL7035 White

Doors

- Door options are available.
- Front door 4 and rear door 3 point locking systems
- Doors can be opened to 230 degree.
- Doors can be opened to left or right direction

Mounting Rails

- 19" Mounting rails; adjustable in depth of the cabinet
- 1.5mm DX51D galvanic

Side Panels

- Locking system is available, Side panels are removable.

Loading Capacity

- Recommended up to 1500 kg Loading capacity

Ground contact

- Caster and levelling feet are included to standard configuration
- Plinth is available as an option.

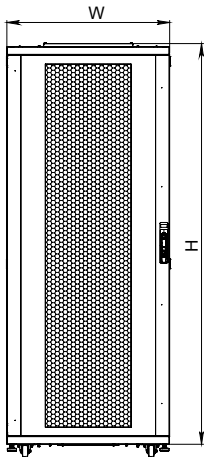

FRONT VIEW

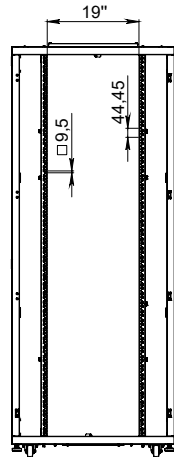

FRONT VIEW WITHOUT DOOR

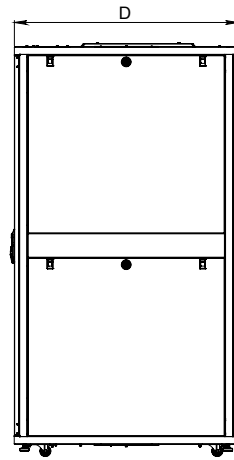

SIDE VIEW

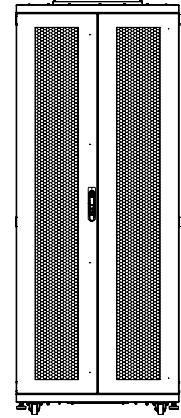

REAR VIEW

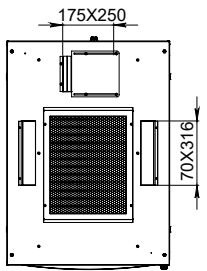

TOP VIEW

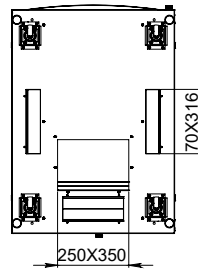

BOTTOM VIEW

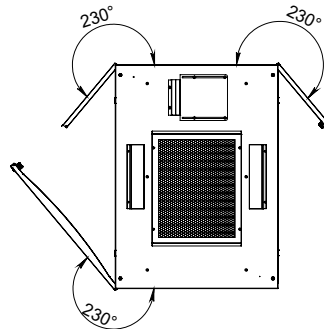

DOOR OPENING ANGLE

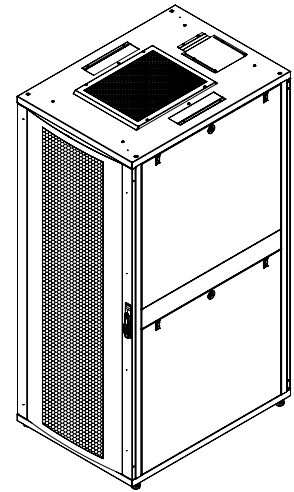

ISOMETRIC VIEW

19" Ager Free Standing Server Cabinets W=800mm D=1100mm

Product Code	Product Description	Height Size in U	Width (w) (mm)	Depth (D) (mm)	Height (H) (mm)	Weight (Net) (kg)	Weight (Gross) (kg)
AG-SR24U8011XX-0000-A-YY	24U 19" Ager Free Standing Server Cabinets W=800mm D=1100mm	24U	800	1100	1173	94,2	116,2
AG-SR26U8011XX-0000-A-YY	26U 19" Ager Free Standing Server Cabinets W=800mm D=1100mm	26U	800	1100	1261	98,8	120,8
AG-SR32U8011XX-0000-A-YY	32U 19" Ager Free Standing Server Cabinets W=800mm D=1100mm	32U	800	1100	1527	112,8	134,8
AG-SR36U8011XX-0000-A-YY	36U 19" Ager Free Standing Server Cabinets W=800mm D=1100mm	36U	800	1100	1704	122,2	144,2
AG-SR42U8011XX-0000-A-YY	42U 19" Ager Free Standing Server Cabinets W=800mm D=1100mm	42U	800	1100	1970	136,2	158,2
AG-SR45U8011XX-0000-A-YY	45U 19" Ager Free Standing Server Cabinets W=800mm D=1100mm	45U	800	1100	2103	143,2	165,2
AG-SR47U8011XX-0000-A-YY	47U 19" Ager Free Standing Server Cabinets W=800mm D=1100mm	47U	800	1100	2192	147,8	169,8

XX = Colour Code, B1 White RAL 7035, S1 Black RAL 9005, during order please specify the colour choice
 Please consider when used levelling feet 30mm add to height, in castor add 80mm.
 0000 = Please check the Door Options page.
 YY = M1 for pre-assembled, D1 for flat pack.

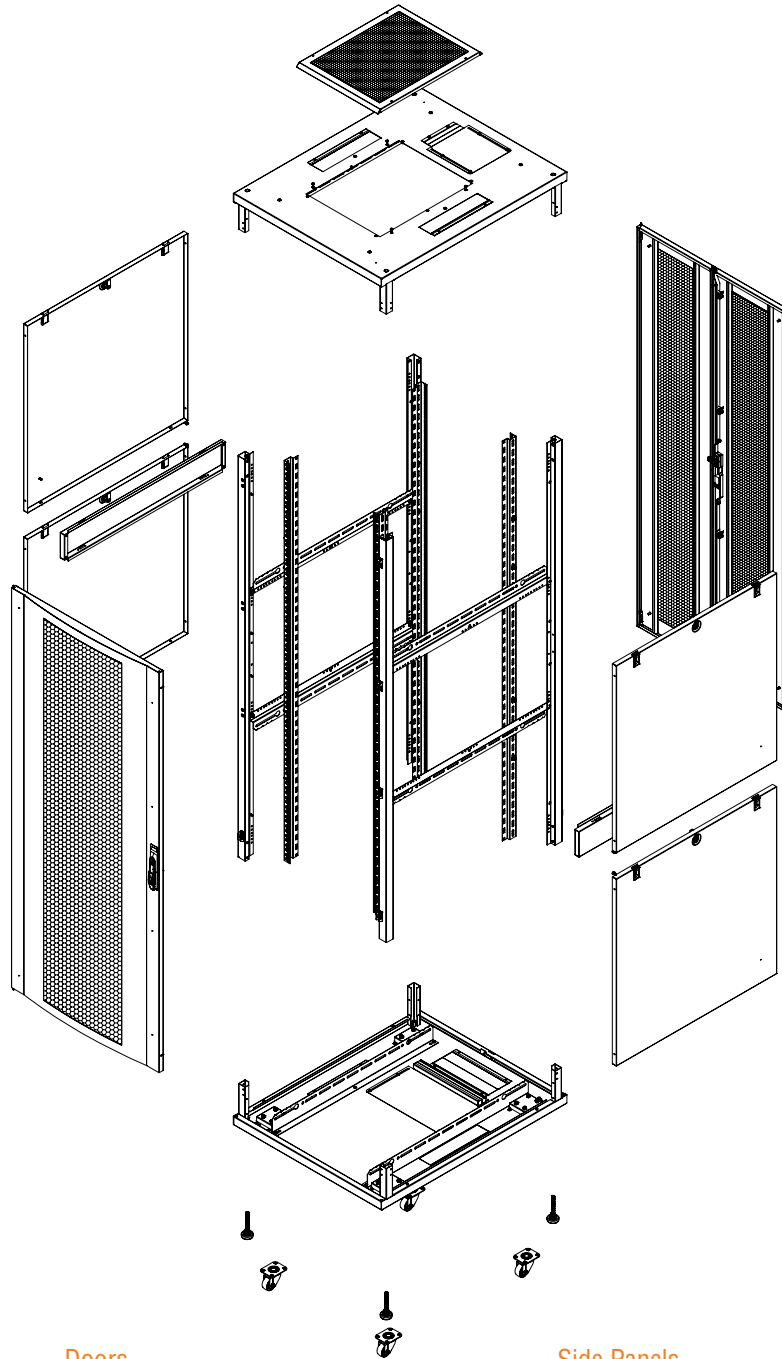

Material

- 1.5 mm DKP

IP Classification

- As a standard IP20
- IP40 when solid metal panel applied for all access

Color Options

- RAL9005 Black
- RAL7035 White

Doors

- Door options are available.
- Front door 4 and rear door 3 point locking systems
- Doors can be opened to 230 degree.
- Doors can be opened to left or right direction

Mounting Rails

- 19" Mounting rails; adjustable in depth of the cabinet
- 1.5mm DX51D galvanic

Side Panels

- Locking system is available, Side panels are removable.

Loading Capacity

- Recommended up to 1500 kg Loading capacity

Ground contact

- Caster and levelling feet are included to standard configuration
- Plinth is available as an option.

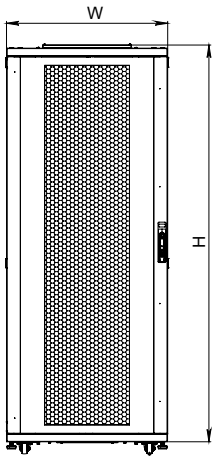

FRONT VIEW

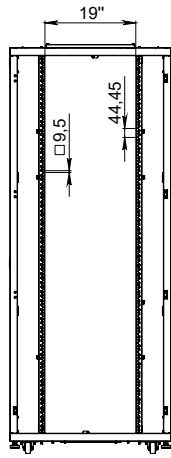

FRONT VIEW WITHOUT DOOR

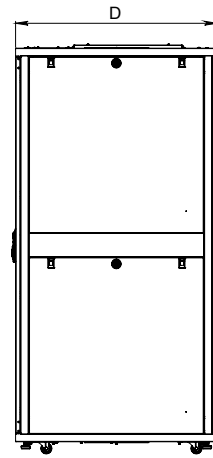

SIDE VIEW

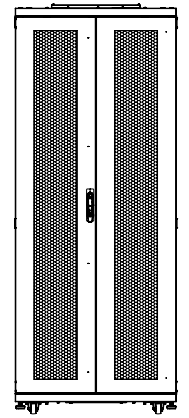

REAR VIEW

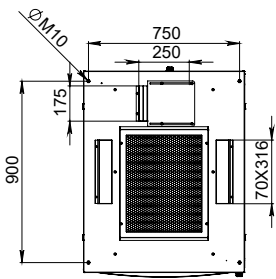

TOP VIEW

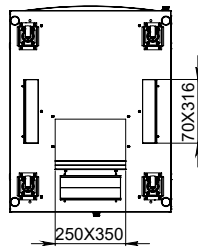

BOTTOM VIEW

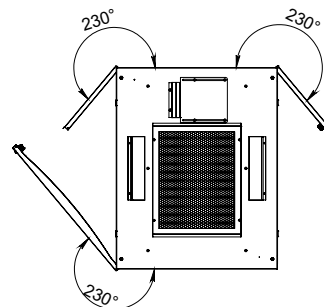

DOOR OPENING ANGLE

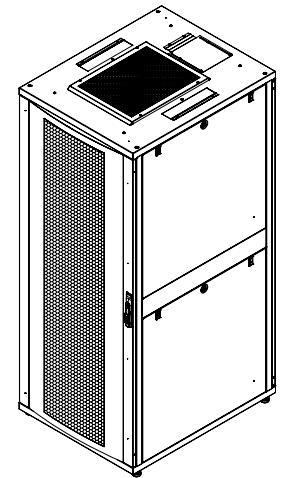

ISOMETRIC VIEW

19" Ager Free Standing Server Cabinets W=800mm D=1200mm

Product Code	Product Description	Height Size in U	Width (w) (mm)	Depth (D) (mm)	Height (H) (mm)	Weight (Net) (kg)	Weight (Gross) (kg)
AG-SR24U8012XX-0000-A-YY	24U 19" Ager Free Standing Server Cabinets W=800mm D=1200mm	24U	800	1200	1173	98	120
AG-SR26U8012XX-0000-A-YY	26U 19" Ager Free Standing Server Cabinets W=800mm D=1200mm	26U	800	1200	1261	102,6	124,6
AG-SR32U8012XX-0000-A-YY	32U 19" Ager Free Standing Server Cabinets W=800mm D=1200mm	32U	800	1200	1527	116,6	138,6
AG-SR36U8012XX-0000-A-YY	36U 19" Ager Free Standing Server Cabinets W=800mm D=1200mm	36U	800	1200	1704	126	148
AG-SR42U8012XX-0000-A-YY	42U 19" Ager Free Standing Server Cabinets W=800mm D=1200mm	42U	800	1200	1970	140	162
AG-SR45U8012XX-0000-A-YY	45U 19" Ager Free Standing Server Cabinets W=800mm D=1200mm	45U	800	1200	2103	147	169
AG-SR47U8012XX-0000-A-YY	47U 19" Ager Free Standing Server Cabinets W=800mm D=1200mm	47U	800	1200	2192	151,6	173,6

XX = Colour Code, B1 White RAL 7035, S1 Black RAL 9005, during order please specify the colour choice

Please consider when used levelling feet 30mm add to height, in castor add 80mm.

0000 = Please check the Door Options page.

YY = M1 for pre-assembled, D1 for flat pack.