

# 10'' WALL MOUNTED **SOHO A** SERIES

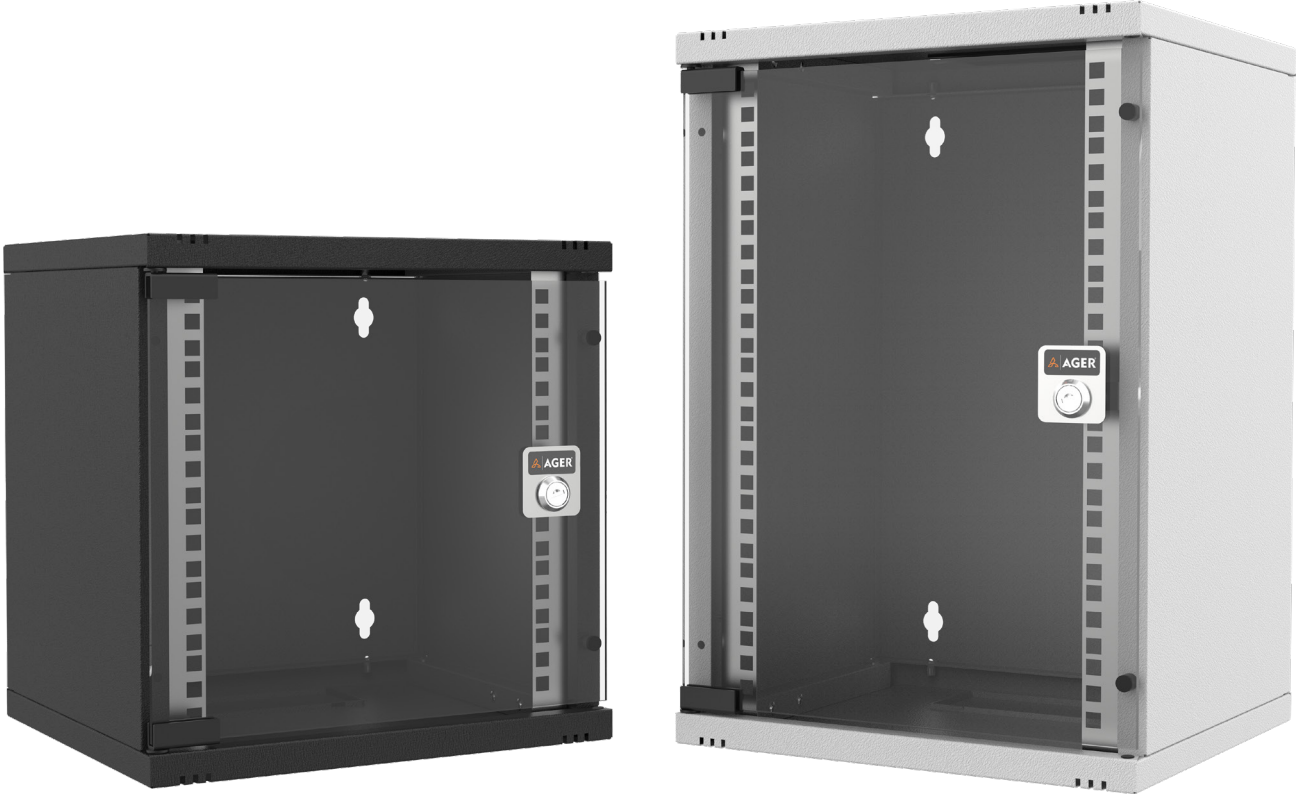

**AGER** Soho cabinets; are used in small-sized network solutions with its solid and simple structure. It adapts to the usage areas such as offices, schools, bank branches, hospitals with its aesthetic visuality.



## Color Options

RAL7035 Light Grey

RAL9005 Black

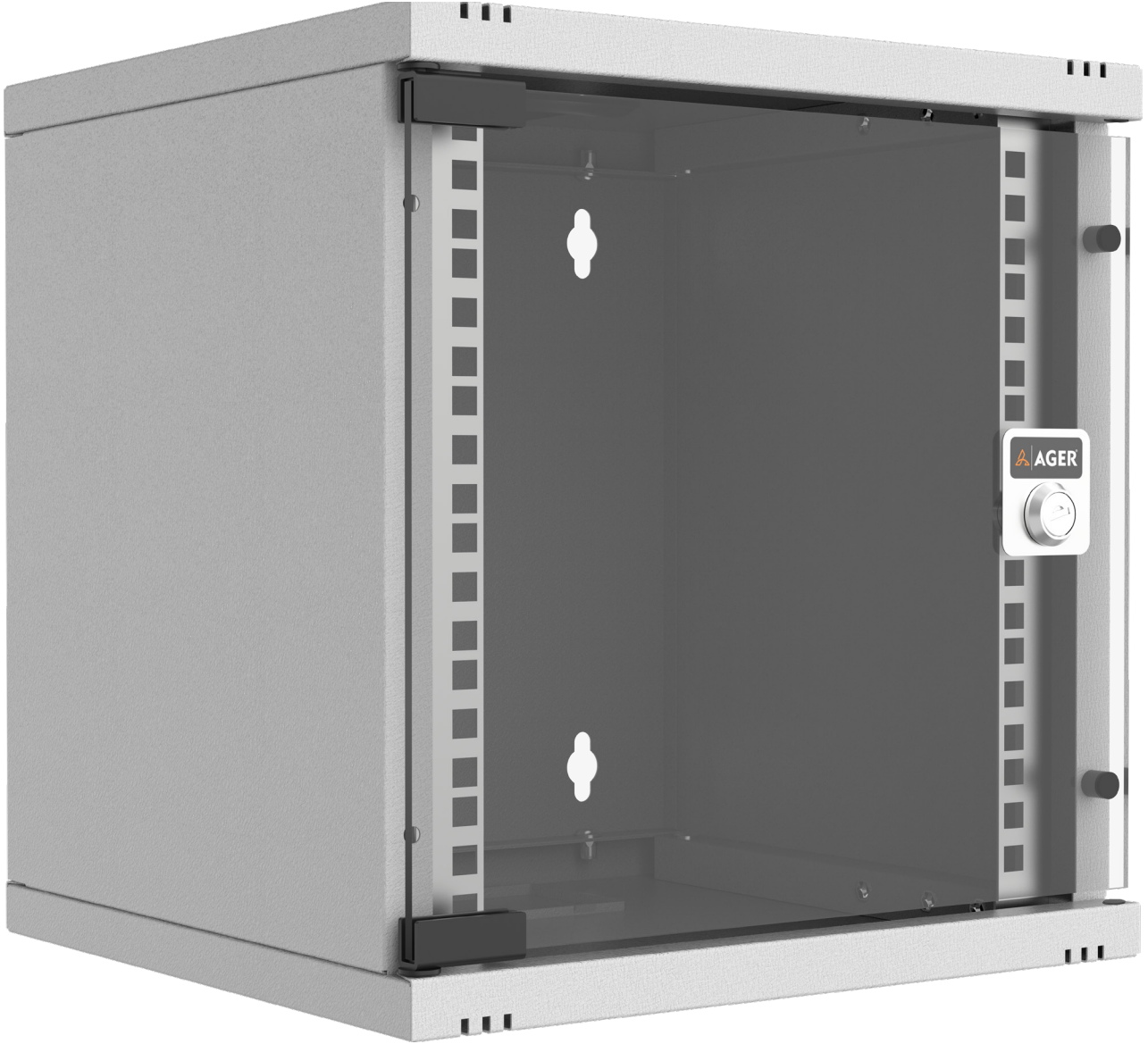

### **Aesthetics**

---

Aesthetic and stylish design helps to adapt easily to usage places. Front glass is 4mm, smoked, tempered, high resistance to fracture and full-length with cam lock.

### **Purposes of Use**

---

Assembly of small systems.  
Network floor distributions.  
Wall type network installation applications.  
Distribution terminal.



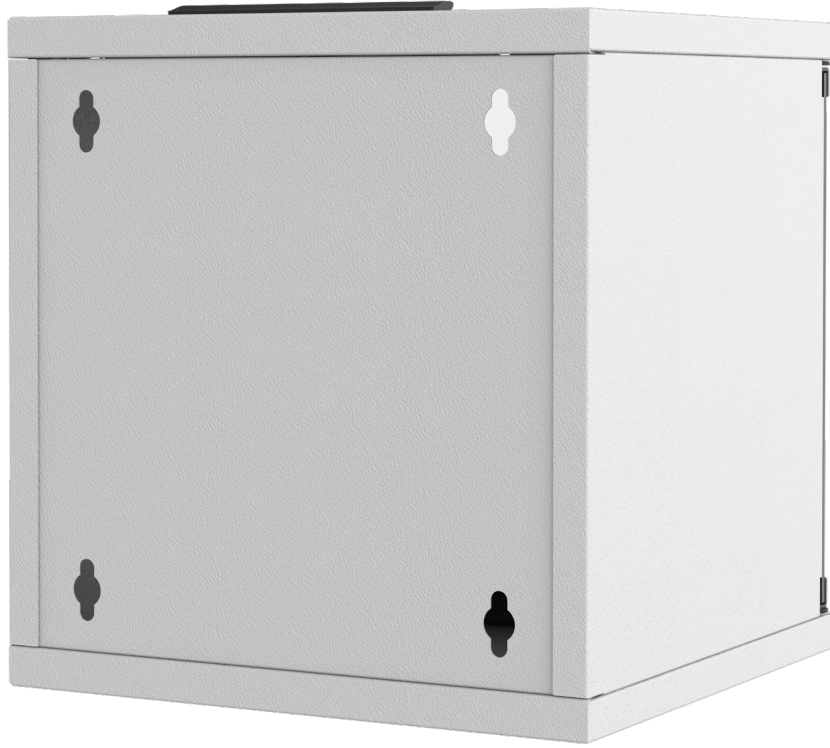

### **Wall Mounting**

---

After fixing the rear panel to wall, the cabinet to be hanged over the rear panel. Then cabinet's fixing to the wall is completed.

### **Cable Entry**

---

There is one cable entry on the top and bottom plate. The top cable entry is a screwless brush and the bottom cable entry has a PVC cover.

The Brush and the PVC cover are interchangeable. Dust entry can be prevented by installing the brush where the cables will enter.

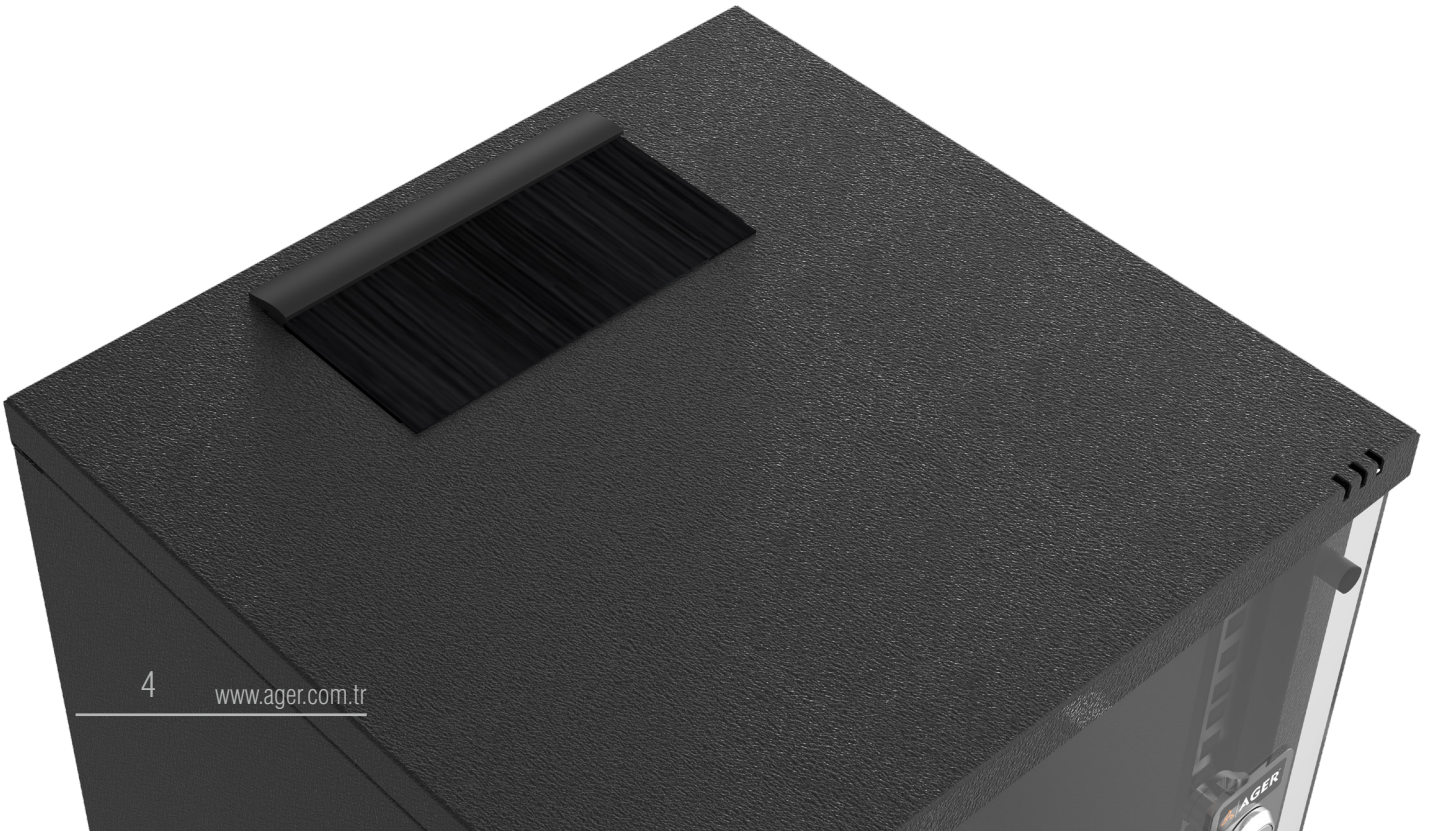

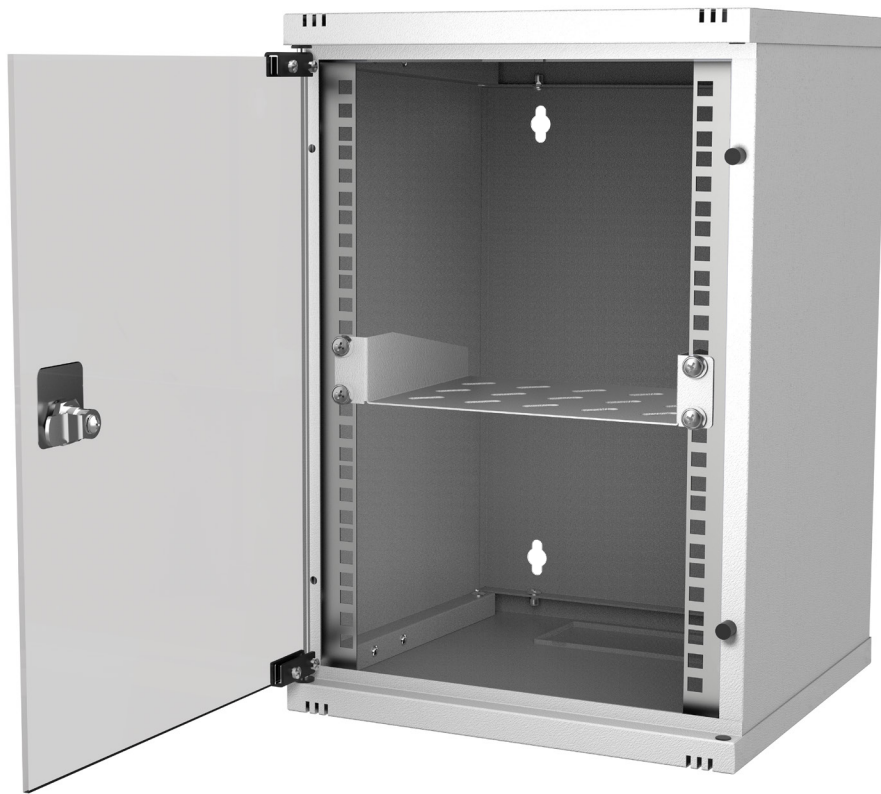

### **Volume**

Soho Cabinets have all the internal volume needed for cabling of Switch, Router Patch, Panel, Socket and similar network equipment.

### **Adjustable Mounting Rails**

According to the dimensions of the devices to be used in the cabinet, mounting rails; can be moved at certain intervals and fixed to the required depth, thus inside of the cabinet is used most efficiently.

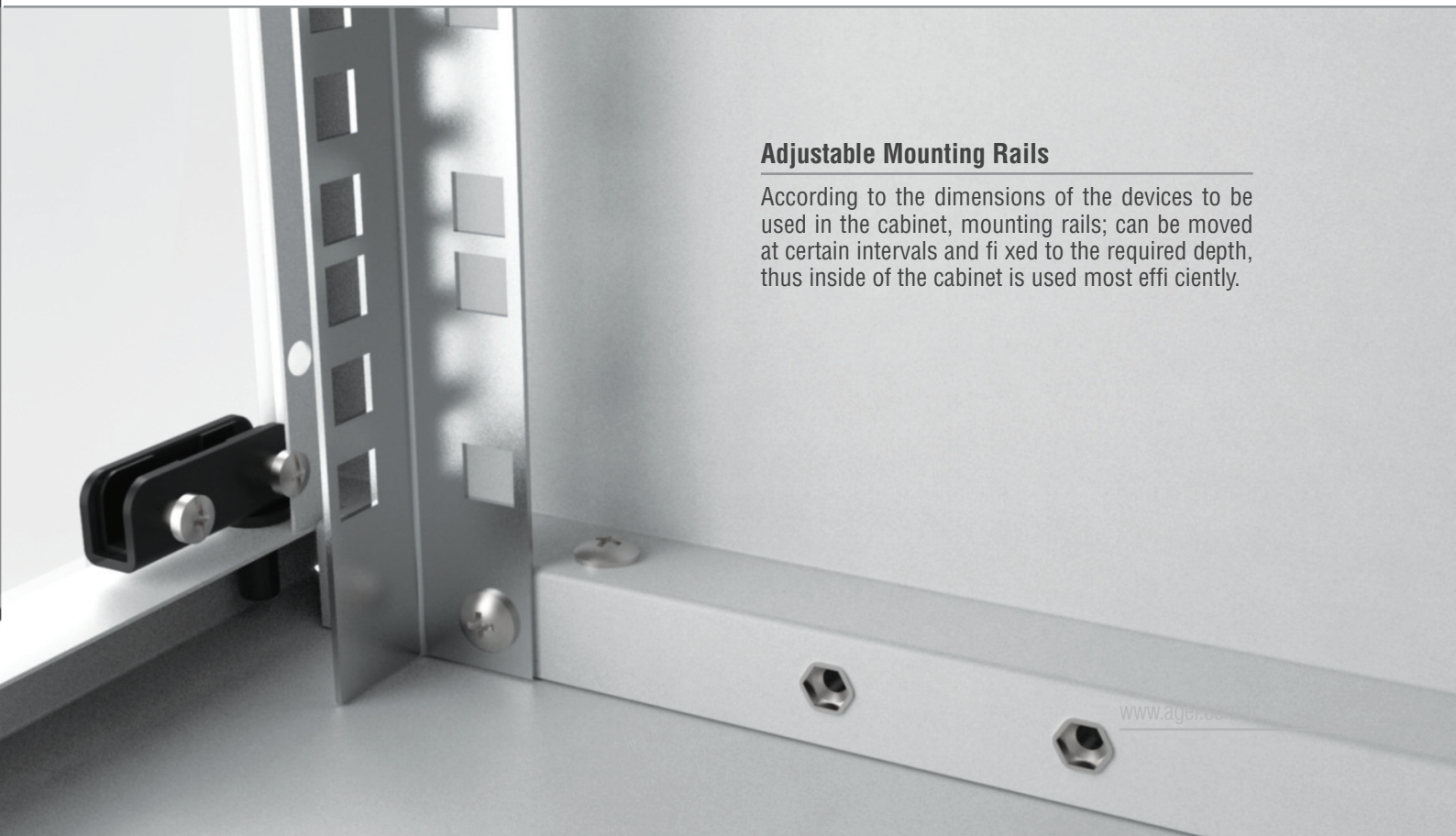

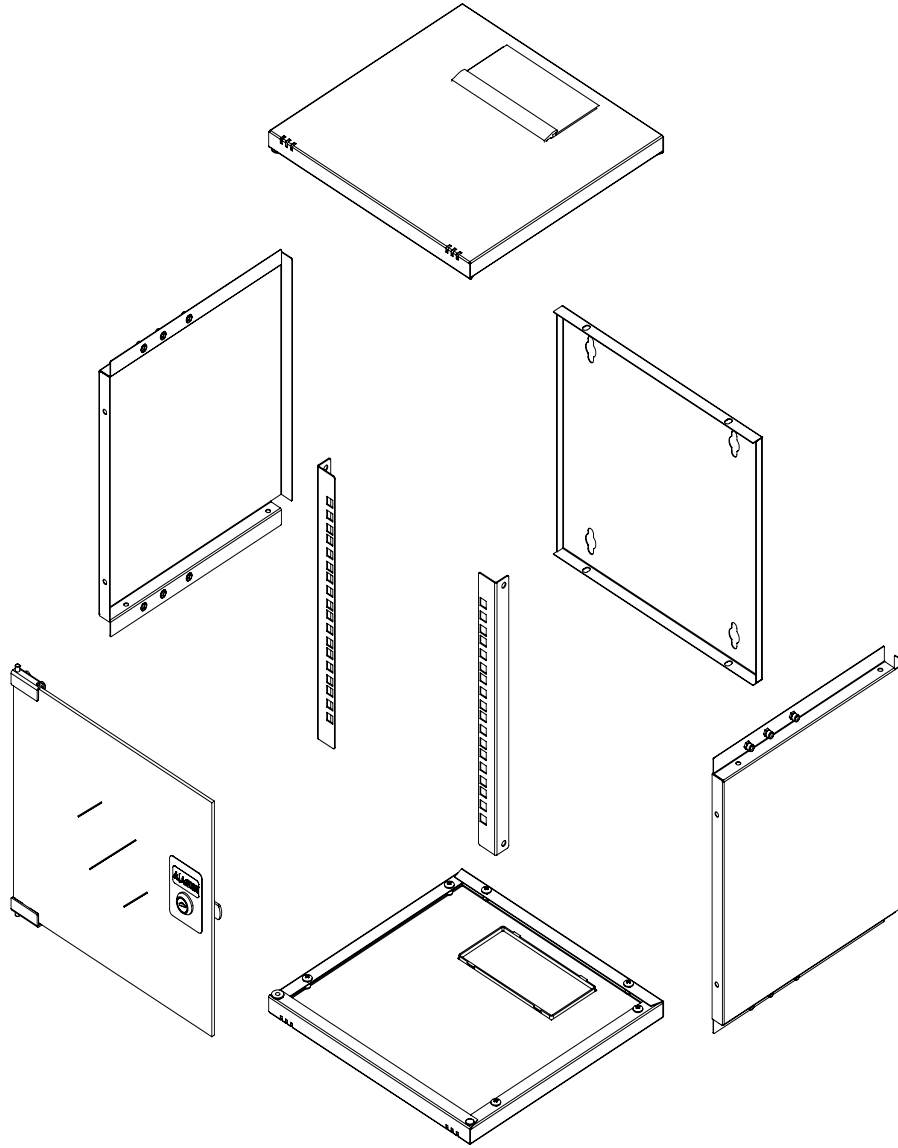

**Material**

- 0.8 mm DKP

**IP Classification**

- As a standard IP20
- IP40 when solid metal panel applied for all access

**Color Options**

- RAL9005 Black
- RAL7035 White

**Doors**

- Door options are available.
- Single point locking system
- Doors can be opened to 120 degree.
- Doors can be opened to left or right direction

**Mounting Rails**

- 10'' Mounting rails; adjustable in depth of the cabinet
- 1.2mm DX51D galvanic

**Bottom**

- PVC cable entry cover is available

**Top Sheet**

- Brushed cable entry is available

**Loading Capacity**

- Recommended up to 30 kg Loading capacity

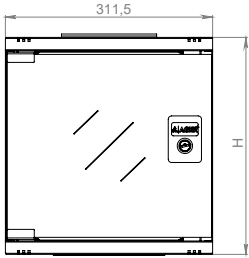

FRONT VIEW

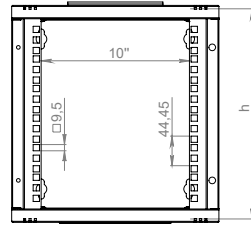

FRONT VIEW  
WITHOUT DOOR

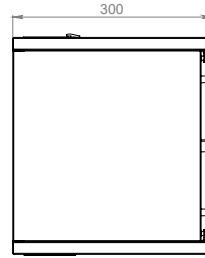

SIDE VIEW

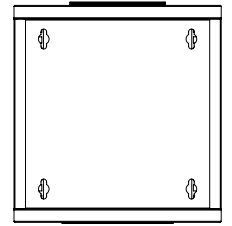

REAR VIEW

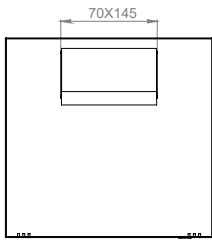

TOP VIEW

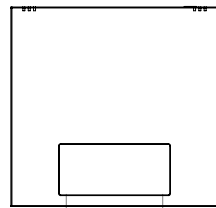

BOTTOM VIEW

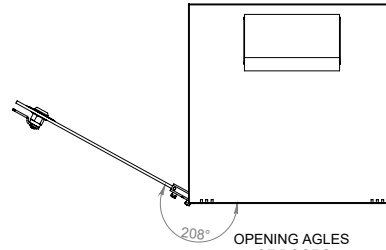

208°  
OPENING ANGLES  
OF DOORS

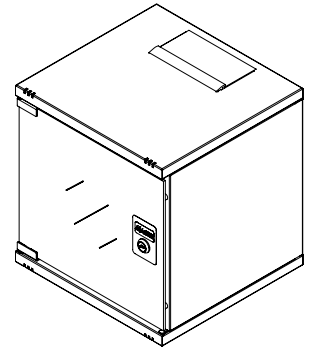

ISOMETRIC VIEW

10" Wall Mounted Ager SOHO Cabinets

Product Code	Product Description	Height Size in U	Width (W) (Mounting rails between)	Width (w) (mm)	Depth (D) (mm)	Height (H) (mm)	Weight (Net) (kg)	Weight (Gross) (kg)
AG-SH04U3030XX-YY	4U 10" Ager Soho Wall Mounted Cabinets W=300mm D=300mm	4U	10"	312	300	237	4,5	5
AG-SH06U3030XX-YY	6U 10" Ager Soho Wall Mounted Cabinets W=300mm D=300mm	6U	10"	312	300	326	5,5	6
AG-SH07U3030XX-YY	7U 10" Ager Soho Wall Mounted Cabinets W=300mm D=300mm	7U	10"	312	300	370	6	6,5
AG-SH09U3030XX-YY	9U 10" Ager Soho Wall Mounted Cabinets W=300mm D=300mm	9U	10"	312	300	459	7	7,5
AG-SH012U3030XX-YY	12U 10" Ager Soho Wall Mounted Cabinets W=300mm D=300mm	12U	10"	312	300	593	8	8,5

XX = Colour Code, B1 White RAL 7035, S1 Black RAL 9005, during order please specify the colour choice.  
YY =M1 for pre-assembled, D1 for flat pack.