

# WALL MOUNTED DVR SERIES



**DVR** series Video & Audio Cabinets; These cabinets are the installation needs of camera and sound systems. Possible products to be installation are network access devices; , wireless devices (Wireless Modem / Router), camera recorders (DVR), connection boxes (Buat or Splitter), Hub / Switch, External Disk etc. It is in the form of PDU group, led monitor and DVR device. It is protected by a single point lock. 24” monitor can be mounted inside. 6 different cable entry points on the cabinet: top, bottom and sides. The maximum loading capacity is 50 kg



## Color Options

RAL7035 Light Grey

RAL9005 Black



### Cooling

Ventilation slots providing passive cooling inside the cabinet

### Mounting

- Inside of door mounting capability for 19" DVR device
- Adjustable fixing plates for device mounting

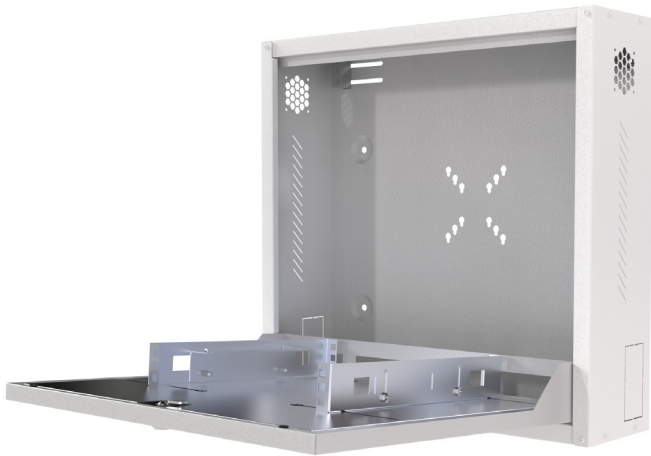

### Mounting

Monitor Connection Points;  
You can connect up to a maximum of 22" 50x50 - 75x75 - 100x100 dimensions monitors

### Loading Capacity

Recommended up to 50 kg Loading capacity

### Devices for Mounted to DVR Cabinet

wireless devices (Wireless Modem / Router), camera recorders (DVR), connection boxes (Buat or Splitter), Hub / Switch, External Disk etc. PDU group, led monitor and DVR device can be mounted.

### Mounting Rails

1U & 2U Adjustable mounting rails



Front View

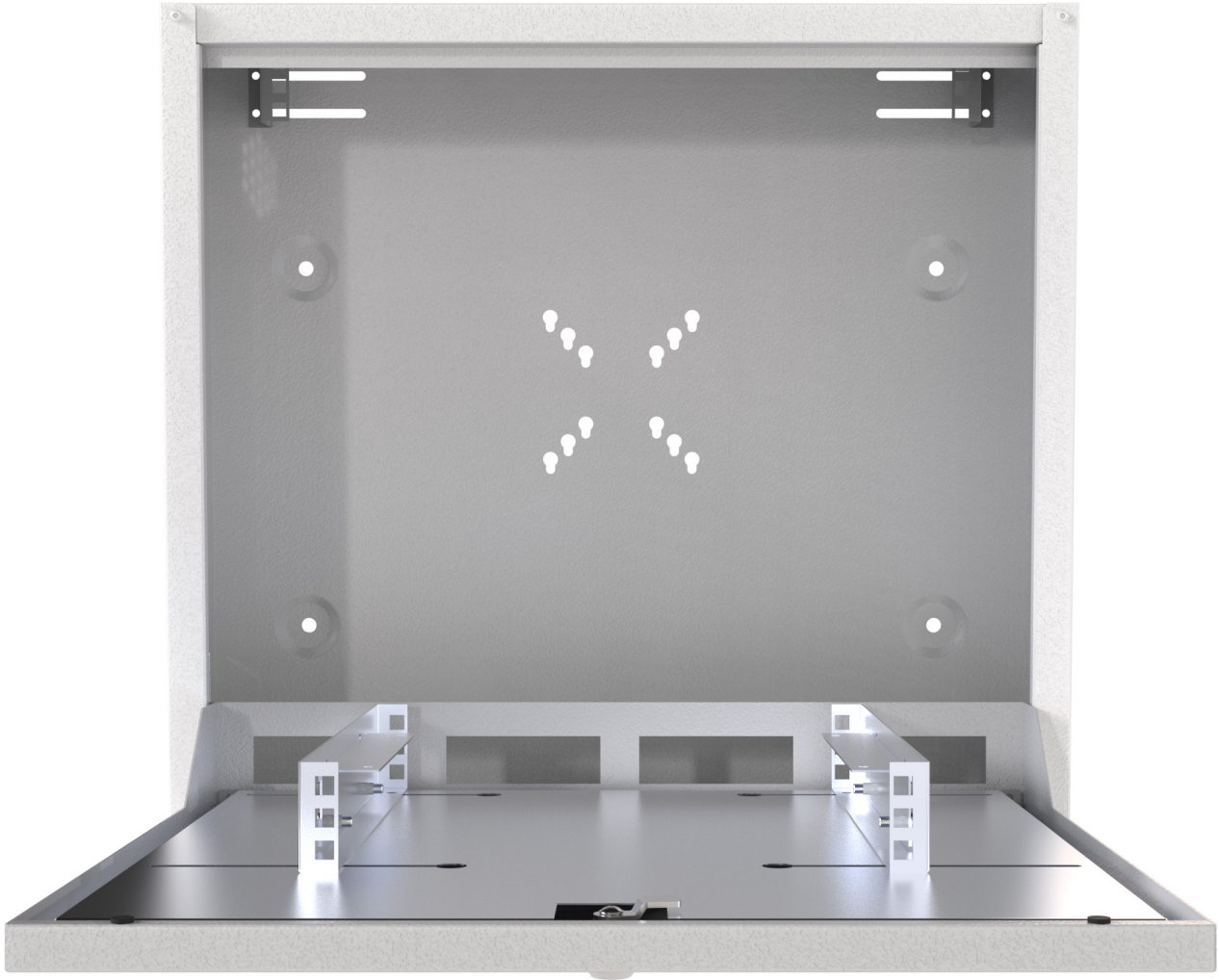

Rear View

**Material**

- 0.8 mm DKP

**IP Class**

- Standart of IP20

**Color Options**

- RAL9005 Black
- RAL7035 White

**Doors**

- Single Point Lock System.
- Doors can be opened 90°.
- Top-down opening is provided.

**Mounting Panels**

- 1.5mm DX51D+ZN275 galvanized material
- mounting panels will be used cabinet according to the depth of the equipment easily adjustable throughout.

**Cable hole**

- There are 6 transition points on the cabinet. It is located at the top, bottom and sides.

**Loading Capacity**

- The maximum loading capacity is 50 kg.

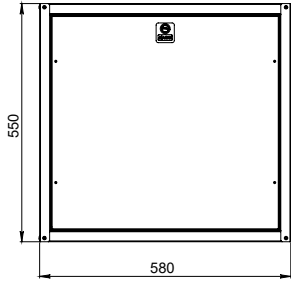

Front View

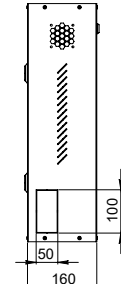

Side View

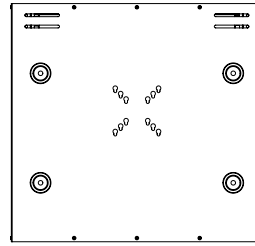

Rear View

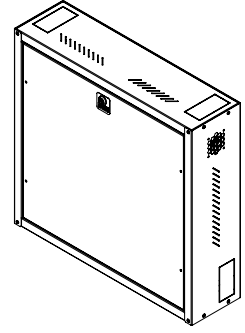

Isometric View

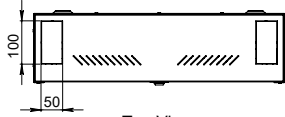

Top View

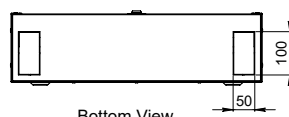

Bottom View

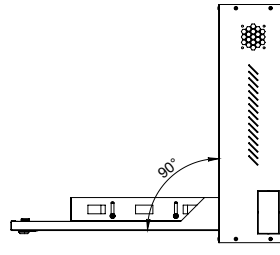

Opening Angle  
Of Door

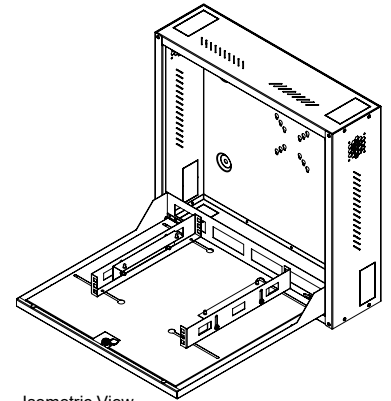

Isometric View

### 19" DVR Video & Audio Sound Cabinets

Product Code	Product Description	Width (Between the Mounting Rails)	Width (w) (mm)	Depth (D) (mm)	Height (H) (mm)	Weight (Net) (kg)	Weight (Gross) (kg)
AG-DVR555816XX-A-M1	AGER 550 x 580 x 160 Montajlı DVR Kabin	450	580	160	550	20	18

XX = Colour Code, B1 White RAL 7035, S1 Black RAL 9005, during order please specify the colour choice  
YY = M1 for pre-assembled, D1 for flat pack